

Al Grieshaber

From: John Giles <JGiles@ecoga.org>
Sent: Tuesday, June 18, 2019 2:24 PM
To: Al Grieshaber
Subject: Cingular and Verizon Agreements
Attachments: Grantville Cingular FINAL Clean 3.6.19.docx; Grantville Cingular FINAL Clean 3.6.19.pdf; Grantville VZ Southwestco FINAL CLEAN 3.6.19.docx; Grantville VZ Southwestco FINAL CLEAN 3.6.19.pdf

Importance: High

Al,
I am following up on the email below from Christine Carling in March, 2019..
ECG is requesting the City of Grantville to execute the attached statewide AT&T (Cingular) and Verizon Agreements

These wireless equipment attachment agreements are necessary to have business to business relationships for the impending small cell wireless activities...
And they are the vehicle that allowed the 52 Public Power members of ECG electric distribution systems (i.e. Grantville) to be exempt from GA Senate Bill 66 legislation

Please contact me if you have any questions..

Giles

P.S. hope to talk with you sometime soon about Swift Link Wireless and the services they provide you..



John Giles
President & CEO
o 770.563.1234 c 770.316.2827
e jgiles@ecoga.org w ecoga.org
1470 Riveredge Pkwy. NW | Atlanta, GA 30328

From: Christine Carling
Sent: Wednesday, March 6, 2019 8:32 AM
To: 'Mark Mitchell'
Cc: 'Al Grieshaber'
Subject: Cingular and Verizon Agreements
Importance: High

Good morning,
Attached are word and pdf versions of the Cingular (AT&T) and Verizon small cell Agreements. If there are any questions, please let me know.

Regards,
Christine

**POLE ATTACHMENT LICENSE AGREEMENT
FOR DISTRIBUTION POLES**

BETWEEN

CITY OF GRANTVILLE

AND

NEW CINGULAR WIRELESS PCS, LLC

TABLE OF CONTENTS

PREAMBLE 3
ARTICLE 1 – SCOPE OF AGREEMENT..... 3
ARTICLE 2 – EXPLANATION OF TERMS 3
ARTICLE 3 – SPECIFICATIONS 7
ARTICLE 4 – ESTABLISHING ATTACHMENTS TO POLES 7
ARTICLE 5 – RADIO FREQUENCY 11
ARTICLE 6 – RIGHT OF WAY FOR LICENSEE'S ATTACHMENTS..... 12
ARTICLE 7 – MAINTENANCE OF POLES AND ATTACHMENTS 12
ARTICLE 8 – DIVISION OF COSTS..... 13
ARTICLE 9 – INSPECTIONS 15
ARTICLE 10 – UNAUTHORIZED ATTACHMENTS..... 16
ARTICLE 11 – ATTACHMENT COUNTS 17
ARTICLE 12 – ABANDONMENT OF LICENSED POLES 17
ARTICLE 13 – POLE ATTACHMENT RENTAL FEES 18
ARTICLE 14 – DEFAULTS 18
ARTICLE 15 – RIGHTS OF OTHER PARTIES..... 19
ARTICLE 16 – ASSIGNMENT OF RIGHTS..... 19
ARTICLE 17 – WAIVER OF TERMS OR CONDITIONS 20
ARTICLE 18 – PAYMENT OF TAXES..... 20
ARTICLE 19 – BILLS AND PAYMENT FOR WORK..... 20
ARTICLE 20 – NOTICES 21
ARTICLE 21 – RESOLUTION OF CERTAIN DISPUTES 22
ARTICLE 22 – TERM OF AGREEMENT 24
ARTICLE 23 – EXISTING CONTRACTS..... 24
ARTICLE 24 – LICENSOR SYSTEM FINANCING OR SALE OF SYSTEM 25
ARTICLE 25 – LIABILITY AND INDEMNIFICATION 25
ARTICLE 26 - COMPLIANCE WITH LAWS; CHANGE OF LAW 27
ARTICLE 26 – CONSTRUCTION 28
ARTICLE 27 – REMEDIES CUMULATIVE 28
ARTICLE 28 – MISCELLANEOUS 28
[SEAL] 30
Exhibit 1 – Application to Attach 31
Exhibit 2 – Annual Attachment Fee..... 33
Exhibit 3 Radio Frequency Emissions Certification..... 34
Exhibit 4 – Approved Contractors 35
Exhibit 5 – ECG Specifications 36

POLE ATTACHMENT LICENSE AGREEMENT FOR DISTRIBUTION POLES

PREAMBLE

THIS AGREEMENT (“Agreement”), effective as of this 1st day of March, 2019 (“Effective Date”), by and between the undersigned municipal corporation of the State of Georgia (the “Licensor”), and New Cingular Wireless PCS, LLC, a limited liability company organized under the laws of the State of Delaware (the “Licensee”), referred to collectively as “Parties,” and individually as “Party”;

WHEREAS, the Licensor and Licensee desire to enter into a pole attachment license agreement for the use of Licensor’s poles, erected or to be erected within the area in which both Parties render service in the State of Georgia, to be consistent with the terms of this Agreement.

NOW, THEREFORE, in consideration of the premises and the mutual covenants herein contained and other consideration set forth herein the adequacy of which is acknowledged, the Parties hereto for themselves, their successors and assigns do hereby agree to the following terms and conditions:

ARTICLE 1 – SCOPE OF AGREEMENT

A. This Agreement will be in effect in the area in which both of the Parties render service in the State of Georgia, and will cover all distribution poles now existing or hereafter erected in the above territory when said poles are brought under this Agreement in accordance with the procedure hereinafter provided.

B. Licensor reserves the right for good cause to exclude from use any of its facilities for objective reasons of safety, reliability, capacity, and generally applicable engineering standards.

ARTICLE 2 – EXPLANATION OF TERMS

A. For the purpose of this Agreement, the following terms will have the following meanings:

“Above the Communications Space” means the space above the Communications Space, as defined below, but not limited to the Power Space and space above the Power Space.

“Actual Costs” means all costs, including, but not limited to, the costs of materials, labor, engineering, supervision, overheads, transportation and contractor fees, when used in lieu of Licensor labor. Licensor Actual Costs will be verifiably comparable to the cost Licensor pays for similar work to its own facilities.

“Affiliate” means any entity that controls, is controlled by, or is under common control with Licensee.

“Application” means the process described in Article 4 hereof used by the Licensee to receive Licensor’s permission to install initial facilities, to modify existing facilities, or to add additional facilities outside the Licensee’s allocated twelve inches (12”) of space on Licensor’s poles, as provided herein. The form used for the Application process is identified as Exhibit 1 and is included as a part of this Agreement.

“Attachment” means any wire, line, antenna, radios, cabinets, apparatus or related equipment attached to a Pole, including, but not limited to, brackets, cables, Service Drops, power supplies, amplifiers, pedestals, bonding wires, Overlashings, guy wires and anchors required to support unbalanced loads. A single Attachment includes the vertical space consisting of a total of twelve inches (12”) either above or below, but not both, the bolted Attachment, exclusive of riser or conduit.

“Clearance Space” means the space on the Pole below the point where horizontal wire or horizontal cable equipment may not be installed in accordance with the Specifications. For purposes of this definition, “horizontal” means spanning from Pole to Pole or extending more than three feet (3’) from the surface of the Pole.

“Communications Space” means the space on the pole immediately below the Power Space extending to the lower of the existing lowest horizontal cable attachment, as specified by the National Electrical Safety Code, or reserved space, if applicable.

“Contact Person” is defined in Article 20.

“Cost in Place” means the cost of the bare pole, labor to install the pole and associated overheads, including engineering.

“Effective Date” is defined in the Preamble.

“Licensor” is defined in the Preamble.

“Force Majeure Event” is defined in Article 28.

“Inventory” means an Inventory of Licensee’s Attachments which will confirm the total number of Licensee’s Attachments, a summary of obvious non-conforming Attachments and any pending Licensee Transfers to Licensor poles.

“Interference” for the purposes of this Agreement, may include, but is not limited to, any use on the property or surrounding property that causes electronic or physical obstruction with, or degradation of, the communications signals from the communication facility.

“Joint User” means a person or entity that is currently occupying or reserving space on Licensor’s Poles, and has a right to attach to a Pole or anchor owned, controlled, or otherwise operated by Licensor in return for granting Licensor equivalent rights of Attachment or occupancy to poles and/or anchors, which the Joint User owns.

“Licensed Pole” means a pole for which Licensee has a valid and effective permit to locate and maintain an Attachment to the terms of this Agreement.

“Licensee” is defined in the Preamble.

“Licensee Transfer Date” is defined in Article 7.

“Licensor” is defined in the Preamble.

“Make Ready” means all work necessary or appropriate to make space for or otherwise accommodate new, additional or changed Attachments, including, but not limited to, necessary or appropriate Rearrangements, removal and replacement of the pole, Transfers and other work incident thereto.

“Make Ready Costs” means all costs necessary for Licensor, and other existing parties on the applicable Pole, to prepare the Poles for Licensee’s new, additional or modified Attachments, including, but not limited to, the costs of materials, labor, engineering, supervision, overheads, and tree trimming costs. Engineering includes design, proper conductor spacing and bonding, calculations to determine proper ground clearances and pole down guy and anchor strength requirements for horizontal and transverse loading, and compliance with all applicable requirements. Also included among Make Ready Costs are the costs of installing or changing out primary Poles, secondary Poles and drop and lift poles, including the cost of installation and/or removal of guys, anchors, stub poles, materials and equipment, temporary construction and all other construction in accordance with the technical requirements and specifications as outlined in this Agreement. Licensor Make Ready Costs will be verifiably comparable to the cost Licensor pays for similar Make Ready Work to its own facilities.

“Make Ready Estimate” means the estimate prepared by Licensor for all Make Ready Work that may be required by Licensor to accommodate Attachment(s) by Licensee.

“Make Ready Work” means all work required by Licensor or others attached to the Pole to accommodate Attachment(s) by Licensee.

“NESC” is defined in Article 3.

“Outside Party” or “Third Party” is defined as persons or entities not party to this Agreement.

“Parties” is defined in the Preamble.

“Pole” or “pole” means a wooden, concrete or steel structure owned, controlled, or otherwise operated by Licensor to support distribution lines and related facilities of Licensor, including drop, lift, and light poles, and streetlight poles which do not support distribution lines and related facilities.

“Power Space” means any space on the pole primarily utilized by Licensor for the distribution of electric power, space between power lines, and includes the space from the top of the pole down to the Communications Space and includes the space above the Communications Space designated by the National Electrical Safety Code as the “communication worker safety zone”.

“Rental Fee,” “rental fee,” “Rental” or “rental” means the annual amount per billable Attachment (as defined herein) that Licensee must pay to Licensor pursuant to Article 13 of this Agreement.

“Rearrangement” means the moving of Licensee Attachments, the Licensor’s equipment or a third party’s equipment from one position to another on the same Pole.

“Referee” is defined in Article 21.

“Safety Inspection” means an inspection of Licensor poles to identify and remediate non-conforming Attachments (e.g. NESC violations) and other safety conditions on Licensor poles, performed after the Effective Date.

“Service Drop” means a Licensee wire or other facility used to connect to a Licensee’s customer’s location from a Licensor pole.

“Specifications” is defined in Article 3 hereof.

“Transfer” means the removal of Attachments from one Pole and the placement of such Attachments upon another Pole.

“Unauthorized Attachment” means any affixation of any Licensee Attachment to Licensor Poles, which has not been authorized as required by this Agreement.

“Unauthorized Attachment Fee” means the fee to be paid by Licensee for each Unauthorized Attachment.

B. The following rules of interpretation apply to this Agreement and are by this reference incorporated into this Agreement:

- (1) the word “or” is not exclusive and the words “including” or “include” are not limiting;
- (2) the words “hereby,” “herein,” “hereof,” “hereunder” or other words of similar meaning refer to the entire document in which it is contained;
- (3) a reference to any agreement or other contract includes permitted supplements, amendments and restatements;
- (4) a reference to a law includes any amendment or modification to such law and any rules or regulations promulgated thereunder or any law enacted in substitution or replacement therefore;
- (5) a reference to singular includes plural and vice-versa and each gender includes the other;
- (6) a reference to days, months, or years refers to calendar days, months, and years, unless business days are specified;
- (7) Article and Section headings and table of contents are only for reference and are not to be considered in interpreting this Agreement;

- (8) a reference to an Article, Section, Appendix, Exhibit or Schedule which does not specify a particular document is to the relevant Article, Section, Appendix, Exhibit or Schedule of the document containing the reference;
- (9) a reference to an Article includes all Sections and subsections contained in such Article, and a reference to a Section or subsection includes all subsections of such Section or subsection;
- (10) All terms not otherwise defined herein will have the meaning commonly ascribed thereto in the relevant industry;
- (11) "\$" or "dollars" refers to United States dollars; and
- (12) The word "will" has the same meaning as "shall."

ARTICLE 3 – SPECIFICATIONS

A. The use of the Poles covered by this Agreement will be in conformity with all applicable provision of the following (the "Specifications"): (1) Section 5 "Joint Use and Clearances" of the Electric Cities of Georgia Inc. Construction Assembly Specifications (a copy of which is attached hereto as Schedule 3 and incorporated herein by this reference) as it applies to Licensee's Attachments, and subsequent revisions thereof, provided Licensor has given Licensee sixty (60) days written notice of such revisions; and (2) requirements of the National Electrical Safety Code (2012) of The Institute of Electrical and Electronics Engineers, Incorporated and subsequent revisions thereof ("NESC"). Where there is a disagreement between Specifications, the applicable NESC Specifications will apply. Modifications of, additions to, or construction practices supplementing wholly or in part the requirements of the Specifications will, when accepted in writing by both Parties hereto, likewise govern the Licensee's use of Poles, and when so accepted will be included within the term "Specifications." Any revision to the Specifications will apply on a prospective basis, except as otherwise required by the NESC or any applicable law. No Application is necessary to correct safety violations or comply with applicable Specifications.

B. Each Party will keep its Attachments in safe condition and in thorough repair. Licensee's Attachments will be identified consistent with the Georgia Overhead Marking Standards as adopted by the Georgia Utilities Coordinating Council. Attachments previously in place on Licensor's Poles will be so identified by Licensee as regular or emergency work occurs or at the next system rebuild opportunity, but not later than five (5) years from the Effective Date of this Agreement. Licensee will be responsible for periodically inspecting its Attachments to ensure they have permanent identification markers. After the fifth year, should Licensor encounter any of Licensee's Attachments without permanent identification markers, Licensor may notify Licensee, provided that Licensor can identify the Attachments as belonging to Licensee. If the markers are not placed within sixty (60) days of such notice, then Licensor may install the necessary markers, and Licensee will reimburse Licensor for the cost of such work.

ARTICLE 4 – ESTABLISHING ATTACHMENTS TO POLES

Before Licensee will make use of Licensor's Poles under this Agreement, or modify existing attachments, it will submit an Application, as required herein. The Application will be sent

either (i) by electronic mail with electronic mail "read" receipt obtained, (ii) hand delivery or (iii) by being deposited in the United States mail with proper postage and properly addressed to the person receiving the Application. When transmittal is by hand or U.S. mail, the Licensee will also send an electronic mail message, return receipt requested, to Licensor as notice that the Application was hand-delivered or sent by the U.S. mail.

A. APPLICATION AND NOTIFICATION PROCEDURE

1. Except in connection with (i) Pole Transfers, (ii) correcting noncompliance, (iii) removals, (iv) modifications subject subsection (2) below, or (v) any other written Licensor requested action of the Licensee, Licensee must submit to Licensor an Application for any Licensee construction on Licensor Poles (including reconstruction of existing Pole lines) that involves the placement of new or additional Attachments.

2. Subsequent to the original installation of Licensee's Attachments, Licensee may make modifications to or replace Licensee's Attachments, or may alter, enhance, and upgrade its Attachments, so long as such modification, replacement, substitution, alteration, enhancement, or upgrade does not increase pole loading beyond the pole loading that was established in the approved Application or involve placement of Attachment outside the area designated in the approved Application, without obtaining prior written consent of Licensor. Any modification that would involve increasing the pole loading or outside the area designated beyond what was established in the approved Application will require Licensee to submit a new Application for such pole.

3. Licensee will submit a completed Application on the form attached hereto and identified as Appendix A, and all supporting data in accordance with said Application, or such other form as may be mutually agreed upon, specifying fully, to the extent applicable, the information shown on Appendix A.

Application Fee – Licensee will be charged in the amount of fifty dollars (\$50) for each Pole submitted under this Agreement. Licensor will keep a cumulative annual total of Application Fees and invoice Licensee for such Application Fees annually, along with the annual Rental Fees. The invoice provided for herein will be paid by the Licensee simultaneously with its payment of the annual Rental Fees. Failure to include all pertinent information relating to the Application set forth in Appendix A will result, at the Licensor's option, in the returning of the Application to Licensee unapproved or holding the Application until the required documentation is received. Licensor will make timely and reasonable efforts to contact Licensee should its Application be incomplete.

Inspection Fee – Except for any work required by Licensor, including, but not limited to, Transfers and rearrangements done at the request of Licensor or a third party, road improvement projects, and the installation of new Poles where none currently exist, Licensee will reimburse Licensor for the Actual Costs incurred by Licensor in performing necessary field inspections and preparation of an estimate of the Make Ready Costs of each Pole covered in the Appendix A. The Licensor will provide, as a deliverable for the above inspection fees, a Pole inspection report with appropriate data as the Parties may agree upon. Licensee will reimburse Licensor for such costs within sixty (60) days of receipt of the invoice from Licensor.

Timeframes:

- (a) Licensor will approve, approve with conditions (e.g., if Make Ready is required), or deny Licensee's Application within sixty (60) days after the receipt of a completed Application, provided that, all attachments at all locations of the Application are substantially similar.

If Licensee's Application is approved or if Licensee's Application is not rejected within the applicable period specified above, the Application will be considered approved and the Licensee will have the right to place Attachments on such Pole(s) as provided in this Agreement. If Licensee's Application is conditionally approved, Licensor will include a Make Ready Estimate with its response. If the Licensor rejects the Application in whole or in part, the Licensor will specify the reason(s). The Application will be rejected only for good cause, as provided for in Article 1.

4. The Make Ready Estimate will offer sufficient detail so that Licensee can readily identify the components of the proposed Make Ready Work and will reflect costs that are verifiably comparable with Licensor Actual Costs. If necessary, the Licensee will request clarification on the Make Ready Cost before requesting the Licensor to commence Make Ready Work. The Licensor's total charges will be consistent with Article 8 herein (will not exceed 120% of the estimate), unless such additional costs are caused by changes in Licensee's plans from the original permit. Licensee will provide written acceptance of the Make Ready Estimate within fourteen (14 days) of receipt. If written response, is not provided within fourteen (14) days, the Application will be considered denied.

5. Licensor will complete Make Ready Work on Applications within sixty (60) calendar days of receipt of Licensee's written acceptance of the Make Ready Estimate for such Make Ready Work. Licensee may request expedited handling of Licensor's work, and Licensee will be responsible for the additional Actual Costs incurred by Licensor for such expedited processing. Licensee is responsible for coordination of all other Licensees or Joint Users to similarly expedite the completion of all Make Ready Work. Licensee will make payment for Licensor's Make Ready Work within sixty (60) days of the written acceptance.

6. Any work undertaken on or in furtherance of Licensee's use of the equipment Above the Communications Space of any pole, will be performed by Licensor's employees, Licensor's contractors, or approved contractors (Exhibit 5). Unless otherwise specifically approved in advance by Licensor, neither the Licensee, nor its contractors will be allowed to perform the Make-Ready Work related to Licensee's equipment Above the Communications Space.

7. Licensor will provide written notice to Licensee no later than seven (7) business days following the completion of Make Ready Work. Upon receipt of notice by Licensee from Licensor that the Make Ready work has been completed, the Licensee will have the right hereunder to place its Attachments in accordance with the terms of the Application and this Agreement (including Article 3 herein). If the Licensee fails to initiate construction within one hundred eighty (180) days from the Licensor's notice of completion of Make Ready Work, the Licensor may, in its sole discretion, deem the Application approval terms and conditions outlined in the Appendix A null and void,

and require the submission of another Application, along with engineering fees necessary to reimburse the Licensor for revised engineering and cost estimates, in the event Licensee still desires to attach to the Poles originally approved for attachment. Where field conditions preclude such compliance (e.g., when the Licensee's construction is delayed), Licensee will notify the Licensor prior to the one hundred eightieth (180th) day. Licensee will provide written notice to Licensor no later than twenty (20) business days following the completion of Licensee's work so that Licensor may perform its inspection of Licensee's new or modified Attachments to Licensor's Pole.

(a) Licensee and Licensor will each place, Transfer and rearrange its own Attachments and will place guys and anchors to sustain any unbalanced loads caused by its Attachments. Anchors and guys will be in place and in effect prior to the installation of Attachments and cables. Each Party will, with due diligence, attempt at all times to execute such work promptly and in such manner as not to interfere with the service of the other Party.

(b) The cost of making Attachments on existing Poles as provided herein, including the making of any necessary Pole replacements, will be borne by the Parties hereto in the manner provided in Article 8.

8. Any work undertaken on or in furtherance of Licensee's use of the equipment Above the Communications Space of any pole, will be performed by Licensor's employees, Licensor's contractors, or approved contractors (Exhibit D). Unless otherwise specifically approved in advance by Licensor, neither the Licensee, nor its contractors will be allowed to perform the Make-Ready Work related to Licensee's equipment Above the Communications Space. For Licensor's failure to meet the required timelines for Make-Ready Work Above the Communications Space, as set forth in this section, as applicable, Licensee, after attempting to resolve the dispute, may file a complaint for unreasonable delay on the part of Licensor with the FCC or with the state public utilities commission exercising jurisdiction or other authority; and further, a rebuttable presumption applies in such proceedings that access to Licensor's poles or facilities has not been provided on just and reasonable terms and conditions.

9. Post Inspection. Licensor may perform a post-construction inspection to measure and/or to visually observe Licensee's facilities, within thirty (30) days of completion of construction to ensure the attachment and installation of the Licensee's facilities conform to the requirements of this Agreement. Licensee will bear the reasonable and actual costs of such inspection provided the inspection is completed within thirty (30) days after written notification by Licensee of non-compliance. If the Licensee's facilities are not in compliance, the Licensee will bring its facilities into compliance within thirty (30) days after notification of non-compliance and notify Licensor in writing upon completion. Licensee will bear the reasonable and actual costs of all subsequent inspections necessary to verify the facilities have been brought into compliance. If not brought into compliance within ninety (90) days from initial notification from Licensor, Licensor may have an approved contractor perform the work and Licensee will be responsible for cost.

ARTICLE 5 – RADIO FREQUENCY

A. Radio Frequency Emissions. Licensee is solely responsible for the radio frequency (“RF”) emissions emitted by its equipment. Licensee is jointly responsible for ensuring RF exposure from its emissions, in combination with the emissions of all other contributing sources of RF emissions, is within the limits permitted under all applicable rules of the Federal Communications Commission (“FCC”). To the extent required by FCC rules, Licensee will install appropriate signage to notify workers and third parties of the potential for exposure to RF emissions. Licensee will communicate and cooperate with other pole attachers which emit RF to minimize the number of signs.

B. Each Party and Other’s Responsible for Own Equipment. The Licensor, Licensee and other attachers which emit RF on Licensor’s poles are under a duty and obligation in connection with the operation of its own, facilities, now existing or in the future, to protect against RF interference to the RF signals of Licensor, Licensee, and such other attachers, as applicable, as may emanate or arise. Each party to this Agreement and all others on poles or facilities will endeavor to correct any interference to other networks created by its RF emissions promptly and will coordinate and cooperate with each other relating to the same.

C. RF Power Cut-off Switch. Licensee will install a power cut-off switch on every Licensor pole or facilities to which it has attached facilities that can emit RF energy. In ordinary circumstances, Licensor’s authorized field personnel will contact the Licensee’s designated point of contact provided pursuant to Section 22 to inform the Licensee of the need for a temporary power shut-down. Upon receipt of the call, Licensee will power down its antenna remotely, which power-down will occur during normal business hours and with 24 hours advance notice. In the event of an unplanned power outage or other unplanned cut-off of power, or an emergency, the power-down will be with such advance notice as may be practicable and, if circumstances warrant, employees and contractors of Licensor may accomplish the power-down by operation of the power disconnect switch without advance notice to Licensee and will notify the Licensee as soon as possible. In all such instances, once the work has been completed and the worker(s) have departed the exposure area, the party who accomplished the power-down will restore power and inform Licensee as soon as possible that power has been restored.

D. Emergency After Hours Contact Information. Licensee will provide emergency after hours contact information to Licensor including 24/7 telephone and/or pager information, a list of duty managers by district and escalation procedures. Licensee will be required to include signage which indicates Licensor emergency contact information, Licensee’s emergency contact information, and National Electrical Safety Code (“NESC”) required information.

E. Installation and Upkeep of Sign(s). Licensee is responsible for the installation and upkeep of its sign or signs on each pole. The signage will be placed so that it is clearly visible to workers who climb the pole or ascend by mechanical means. The signs will contain the information approved for such signs by the FCC, or in the absence of FCC approval, the information commonly used in the industry for such signs.

ARTICLE 6 – RIGHT OF WAY FOR LICENSEE'S ATTACHMENTS

While the Licensor and Licensee will cooperate as far as may be practicable in obtaining right-of-way for both parties on Licensed Poles, the Licensor does not warrant or assure to the Licensee any right-of-way privileges or easements on, over or across streets, alleys and public thoroughfares, and private or publicly owned property, and if the Licensee will at any time be prevented from placing or maintaining its Attachments on the Licensor's Poles, no liability on account thereof will attach to the owner of the Poles.

Licensor will maintain pole line right-of-way clearances according to Licensor's standard procedures, except with respect to Make Ready. Licensee is responsible for providing right-of-way clearances outside of Licensor's standard clearance practices at its own expense.

ARTICLE 7 – MAINTENANCE OF POLES AND ATTACHMENTS

A. The Licensor will maintain all Poles in a safe and serviceable condition and in accordance with the Specifications, and will replace, reinforce or repair Poles as they become defective. Licensee acknowledges that Poles and related items carry hazardous voltages, deteriorate over time and may contain various hazardous chemicals or properties. Licensee will instruct and equip its personnel, including its employees, contractors and other agents, of the hazards associated with working on Licensor's Poles, and Licensee will provide necessary training and equipment for its representatives to safely execute their work on Licensor's Poles. Prior to working on a Pole, Licensee will, through visual inspection and reasonable effort, make an assessment that the pole is in safe working condition. If Licensee believes that a pole contains non-compliant or unsafe conditions, Licensee will promptly notify Licensor of any existing substandard condition (i.e., physical, mechanical or electrical, etc.), that jeopardizes either the general public or workman safety, and Licensor will cause the existing condition to be promptly corrected. Licensee will insure that contractors will comply with provisions of this Agreement. Licensor does not warrant, guarantee, or imply that any Pole abandoned by Licensor possesses sufficient mechanical strength as required by or for any use of Licensee.

B. When replacing a Pole carrying terminals of aerial cable, underground connection, or transformer equipment, the new Pole will be set in the same hole which the replaced Pole occupied, or immediately adjacent, and in a manner to facilitate Transfer of Attachments, unless special conditions make it desirable to set it in a different location. Replacement Poles where risers (dips) are installed should be set as close as possible to the existing Pole. The Licensor will make reasonable effort to conduct a joint field review or otherwise coordinate with Licensee to determine the location of the proposed Pole. Reasonable effort will be made to coordinate locations of risers and Service Drops with the locations of the power facilities serving the customer.

C. Except during restoration efforts after natural disasters, such as a Force Majeure events, whenever it is necessary to replace or relocate a Licensed Pole, the Licensor will, before making such replacement or relocation, give notice via the electronic notification system of pole transfer request provided by the National Joint Utilities Notification System ("NJUNS") of not less than sixty (60) days for five (5) poles or less and ninety (90) days for six (6) poles or more (except in case of emergency, when verbal notice will be given and subsequently confirmed in writing) to the Licensee, specifying in such notice the time of such proposed replacement or relocation, and the Licensee will at the time so specified Transfer its Attachments to the new or relocated Pole. On highway relocation projects, the schedule for

Transfers will be consistent with the "utility adjustment schedule" and any subsequent revisions or with any other schedule issued by the appropriate authority governing a highway relocation project.

NJUNS code Licensor CTYGVL

NJUNS code Licensee ATMDEK

D. Should the Licensee fail to Transfer its Attachments to the newly Licensed Pole after the date specified for such Transfer of Attachments and after all third party and Licensor responsible Transfers have been accomplished to the extent necessary for Licensee to affect its facilities Transfer, whichever is later ("Licensee Transfer Date"), the parties will have the following rights, in addition to any other rights and remedies available under this Agreement: The Licensor may hire a contractor approved by Licensee to transfer the facilities at Licensee's cost. Licensee will furnish a list of contractors authorized to perform such transfers. Alternatively, Licensor may sell such Pole to Licensee "as is" and the Licensee will indemnify, defend and save harmless the Licensor from all obligation, liability, damages, cost, expenses or charges incurred thereafter, and not arising out of anything occurring prior to the transfer of ownership. Licensor will further evidence transfer of title to the Pole by appropriate means.

E. Licensee will have twenty-four hour (24/7) access to its equipment in Communications Space for maintenance and repair.

F. Each party will at all times maintain all of its Attachments in accordance with the Specifications in Article 3.

ARTICLE 8 – DIVISION OF COSTS

A. **NEW POLES INSTALLED WHERE NONE CURRENTLY EXIST.** Whenever Licensor requires new Pole facilities within the Licensee's service territory for any reason, including an additional Pole line, an extension of an existing Pole line, or in connection with the reconstruction of an existing Pole line, it will make a best effort to notify Licensee to that effect in writing (verbal notice subsequently confirmed in writing may be given in cases of emergency) stating the proposed location of the new Pole. In the case of emergency, the Licensee will preliminarily respond verbally on an expedited basis that it does or does not want to attach its Attachments and will generally describe its planned Attachments. Within a reasonable period (not to exceed fifteen (15) business days) after the receipt of such written notice, the Licensee will submit an Application. To the extent that Licensee's planned Attachments require a pole taller or stronger than what Licensor would have installed absent Licensee's planned Attachments, the difference between the Cost in Place of such Pole and the Cost in Place of the existing Pole will be paid by the Licensee, the rest of the cost of erecting such Pole to be borne by the Licensor. If in connection with the construction of a Pole(s) the Licensee makes the payment required by this paragraph, then the Licensee will in the future be entitled to attach on such Licensor's Pole(s) even if the Pole(s) does not at that time become a Licensed Pole.

B. **ADDITIONAL MID-SPAN POLE.** A Pole, including all appurtenances or fixtures, erected between Poles to provide sufficient clearance and furnish adequate strength to support the circuits of both the Licensor and the Licensee, which would have been unnecessary except solely due to Licensee's use, will be erected at the sole expense of the Licensee, or in the case

of multiple Licensees on the Licensed Pole, the cost will be equally divided among all Licensees or Joint Users requiring the mid-span Pole.

C. PAYMENTS DO NOT AFFECT OWNERSHIP. Any payments for Poles made by the Licensee under any provisions of this Article will not entitle the Licensee to the ownership of any part of said Poles for which it has contributed in whole or in part.

D. REPLACEMENT OF EXISTING POLES. Where an existing Pole is replaced for maintenance purposes, Licensor will erect a Pole adequate for the existing Attachments and Attachments for which Applications have been delivered, unless such Application is denied in accordance herewith, and the Licensor will pay all the costs of installing the replacement Pole. Licensee will pay to replace its existing Attachments. The replaced Pole will be removed and retained by Licensor.

1. A Pole larger than the existing Pole, which is installed to replace an existing Pole, the extra height or strength of which is due wholly to the Licensor's requirements, such as providing service, normal maintenance, or keeping the Licensor's wires clear of trees, will be erected at the sole expense of the Licensor. The Licensor will bear the full expense of replacing or Transferring all the Licensor's Attachments, and the Licensee will bear the full expense of replacing or Transferring all the Licensee's Attachments.

2. For a Pole larger than the existing Pole, which is installed to replace an existing Pole, the extra height or strength of which is due wholly to the Licensee's requirements, including Licensee's requirements as to keeping the Licensee's wires clear of trees, the Licensee will pay to the Licensor the Make Ready Cost of the new Pole.

3. For a Pole larger than the existing Pole, which is installed to replace an existing Pole, the extra height or strength of which is due wholly to a Joint User's requirements such as providing service, correcting a safety violation or keeping the Joint User's wires clear of trees, the Joint User will pay all of the Make Ready Cost of the new Pole, including any costs associated with replacing or Transferring Licensee's Attachments.

4. Except as to existing contracts with Joint User, in the case of a Pole larger than the existing Pole, which is installed to replace an existing Pole, the extra height or strength which is due to the requirements of all parties on the pole, such as when the parties share responsibility for correcting a safety violation, the difference between the Cost in Place of such Pole and the Cost in Place of the existing Pole will be shared equally by the Licensee and the Licensor, and other third parties, if applicable, the rest of the cost of erecting such Pole to be borne by the Licensor. The Licensor and Licensee will replace or Transfer all Attachments at their own expense.

E. RESPONSIBILITY FOR OWN ATTACHMENTS. Each party will place, maintain, rearrange, Transfer and remove its own Attachments at its own expense except as otherwise expressly provided herein.

F. PAYMENT BASIS. Payments made under the provisions of this Article may be based on the estimated or Actual Cost as mutually agreed upon (including overhead) of making such changes but in no event, however, will either Party be required to pay for such changes more than 120% of the Estimated Cost supplied by the other if such cost estimate will have been requested and furnished before the changes were made.

G. UTILITIES INSTALLING LARGER POLES FOR UTILITY'S FUTURE USE. In the event the Licensor installs a Pole larger than is initially required for Licensor's and Licensee's use in anticipation of Licensor's future requirements or additions, the additional space provided by Licensor will be reserved for Licensor's sole use. Licensee may request documentation to validate the need for future space.

ARTICLE 9 – INSPECTIONS

A. INSPECTION PERFORMANCE. Within a reasonable time, not to exceed two (2) years after the Effective Date of this Agreement, the Parties will jointly perform a safety inspection to identify any safety violations of all parties on the Poles ("Initial Safety Inspection"), including Licensor and Joint Users, except that no such Initial Safety Inspection will occur if Licensee does not have any existing Attachments, which the parties agree is the case here. Following the Initial Safety Inspection, and not more than once every five (5) years thereafter (or five (5) years after execution of this Agreement if an Initial Safety Inspection is not conducted), Licensor may perform periodic system-wide safety inspections of Licensor Poles, including Licensee Attachments, upon six (6) months' advance written notice to Licensee. Such notice will describe the scope of the inspection and provide Licensee with an opportunity to participate. Licensee and Licensor, and other attachers to Licensed Poles, will share equally in the Initial Safety Inspection cost whether the Initial Inspection is performed by the Licensor or a third party contractor. In the event the Initial Safety Inspection or any subsequent safety inspection is performed by a third party contractor, the Licensee will have the right to seek bids from third party contractors prior to the inspection and propose such bids to Licensor. Licensor will not be required to use any third party contractor proposed by the Licensee, provided that any third party contractor used by the Licensor to perform any inspection will charge no more than the lowest qualified bid proposal (in Licensor's reasonable discretion) provided by the Licensee. For inspections performed after the Initial Inspection, Licensee will pay a pro-rata share of the Licensor's inspection costs and will incur its own costs to participate in such periodic safety inspections. The Licensee's pro-rata share of Licensor's cost will be equal to the percentage of the total violations caused by Licensee's Attachments as identified during the inspection.

B. CORRECTIONS. In the event any Licensee facilities are in violation of the Specifications and such violation poses an imminent danger to persons or property and is discovered ("Imminent Danger Violation"), Licensee will correct such violation immediately. Should Licensee fail to correct such Imminent Danger Violation after notice, the Licensor may correct the Imminent Danger Violation and bill Licensee for the Actual Costs incurred. Licensee will not be subject to any safety violation penalties pursuant to the Initial Safety Inspection provided that Licensee corrects any safety violation that is not an Imminent Danger Violation (a "Non-Imminent Danger Violation") discovered during the Initial Safety Inspection within eighteen (18) months of the documentation and reporting of the unsafe conditions. Following the Initial Safety Inspection, if any Attachment of the Licensee is found to be a Non-Imminent Danger Violation of Article 3 herein, and Licensee has caused the violation, Licensee will have sixty (60) days to correct any such violation upon written notice from Licensor, or within a longer, mutually agreed-to time frame if correction of the violation is not possible within sixty (60) days, such extended time to be not more than an additional sixty (60) days. Notwithstanding the foregoing grace periods, in the event Licensor or an Outside Party prevents Licensee from correcting a Non-Imminent Danger Violation, the timeframe for correcting such violation will be extended to account for the time during which Licensee was

unable to correct the violation due to such Licensor or Outside Party's action. Licensee will not be responsible for the costs associated with violations caused by others. In all circumstances, all of the Parties on the Pole will work together to maximize safety while minimizing the cost of correcting any such deficiencies, but the Licensee will be responsible for the full cost of any necessary or appropriate corrective measures associated with violations caused by Licensee, including removal and replacement of the Pole and all Transfers or other work incident thereto. Licensee will insure that its employees, agents, contractors or other Outside Parties, which Licensee causes to work on Licensor Poles, will be notified of pending, unresolved Poles requiring corrective actions prior to activities on such Poles, and Licensee will not allow unqualified or improperly equipped personnel to work on such Poles.

1. If any Attachment of the Licensor is found to be in violation of Specifications and Licensor has caused the violation, then the parties will work together to minimize the cost of correcting any such deficiencies, but the Licensor will be responsible for the full cost of any necessary or appropriate corrective measures, including removal and replacement of the Pole and all Transfers or other work incident thereto.

2. If one or more Outside Party's Attachment caused the violation, then such Outside Party will pay the corrective costs incurred by all who have Attachments on the Pole, including for the Licensee, Licensor and any other attachers; and the Licensor will make reasonable effort to cause the Outside Party to make such payment.

3. If there exists a violation of Specifications and it cannot be determined which party on the Pole, including Joint User, caused such violation or there is a mixture of the parties causing the violation, then the parties will work together to minimize the cost of correcting any such deficiencies, and all parties and Outside Parties who may have caused such violation will share equally in such costs; provided, however, that if a Party can modify its Attachments so that they no longer may be a cause of the violation or deficiency, then such Party may elect to make such modification instead of otherwise sharing in such costs. Such a modification will not relieve a Party from sharing in such costs if the Party making the modification could have been a cause of any deficiency that remains.

C. In the event an Imminent Danger Violation is discovered, Licensee will correct such violation immediately, and, in any case, in no more than twenty-four (24) hours, except as otherwise agreed to by the Parties. Should Licensee fail to correct such Imminent Danger Violation within twenty-four (24) hours after notice or such alternative time period, the Licensor may correct the violation and bill Licensee for the Actual Costs incurred.

ARTICLE 10 – UNAUTHORIZED ATTACHMENTS

If any Attachment is identified for which the Application requirements (as set forth herein), or notification requirements as provided for in Article 4, have not been satisfied ("Unauthorized Attachment"), Licensor will notify Licensee in writing. The Licensee will pay to the Licensor a one-time fee of one hundred fifty dollars (\$150.00) per Unauthorized Attachment. Licensee will also submit a completed application to Licensor within five (5) business days and be subject to the provisions in Article 4.

ARTICLE 11 – ATTACHMENT COUNTS

A. Not more often than once every five (5) years and in conjunction with the established cyclical attachment count, unless otherwise mutually agreed by the parties, inventories of Attachments will be made by representatives of the parties to determine the number of Licensee's Attachments to Licensor Poles ("Actual Inventory"). Licensor will provide three (3) months' advance written notice prior to the Initial Inventory and any subsequent Actual Inventory describing the scope of the Inventories so that Licensee may plan and fully participate in and budget for such Inventories.

B. Unless prevented by the provisions of a third party agreement, Actual Inventories and Initial Inventories will include all Outside Parties attached to Licensor's Poles. Where multiple Outside Parties are included in the inventory, all participating Outside Parties will incur a prorated share of the cost of performing the Actual Inventory, based on the number of Attachments each attacher has on Licensor's Poles. For a year for which there is an Actual Inventory, the Rental Fees provided for herein will be based on the Actual Inventory and the following adjustments will be made:

1. The difference between the number of Licensee Attachments found by the Actual Inventory for the year in question and the number of Attachments for which Licensee was most recently invoiced for Pole Attachment Rental Fees will be prorated evenly based on the assumption that such Licensee Attachments were added evenly over the period since the last Actual Inventory, or five years, whichever period is shorter. In addition, the Unauthorized Attachment fee will apply if applicable.
2. If the number of Licensed Attachments in the previous annual rental invoice is less than the number of Licensed Attachments found by the Actual Inventory, then Licensee will be entitled to a pro-rata refund from the Licensor or a credit to the Licensee based on the assumption that such Licensee Attachments were removed evenly over the period since the last Actual Inventory, or five years, whichever period is shorter..

ARTICLE 12 – ABANDONMENT OF LICENSED POLES

A. To the extent permitted by law, if the Licensor desires at any time to abandon any Licensed Pole, it will, except in the event of required Transfers as provided in Article 7, give the Licensee notice in writing to that effect at least sixty (60) days prior to the date on which it intends to abandon such Pole. If, at the expiration of sixty (60) days, the Licensor and all other third party and Joint Users have no Attachments on pole but Licensee has not removed its Attachments, Licensor may sell such Pole to Licensee "as is" and the Licensee will save harmless the Licensor from all obligation, liability, damages, cost, expenses or charges incurred thereafter, and not arising out of anything occurring prior to the transfer of ownership. Licensor will further evidence transfer of title to the Pole by appropriate means.

B. The Licensee may at any time abandon a Licensed Pole by removing any and all Attachments it may have thereon and by giving written notice thereof.

ARTICLE 13 – POLE ATTACHMENT RENTAL FEES

A. For a year in which there is no Inventory, the number of Licensee's Attachments used in calculating the Rental Fees will be based on the number of Licensee Attachments for which Licensee was charged in the previous year plus the number of Licensee Attachments approved through the Application process since the last billing minus the number of Licensee Attachments for which notice of removal was provided.

B. The applicable computation of payments and calculations as above provided will be made on or about December 15th of each year for the next year's Rental Fees, each Party acting in cooperation with the other.

C. Pole Attachment Rental Fees due from Licensee to Licensor will be as indicated in Exhibit 2. The undisputed Pole Attachment Rental Fee herein provided will be paid by Licensee within sixty (60) days after Licensee's receipt of the invoice.

D. **SPECIFIC RENTAL RATES.** See Schedule 2.

E. Licensor hereby represents and warrants as of the date hereof and covenants and agrees from and after the date hereof that none of the rates or fees offered to any other entity with respect to wireless installations is or will be more favorable to such entity than those imposed on Licensee under this Agreement. If Licensor agrees to a rate or fee that is more favorable than those imposed on Licensee under this Agreement, then Licensee will be entitled under this Agreement to such rate or fee on and after such rate or fee becomes effective.

ARTICLE 14 – DEFAULTS

A. In the event either Party deems an event of default has taken place and prior to engaging in the formal default provisions in this Agreement, the appropriate representatives of the Licensee and Licensor, as identified in Article 20, will meet in person or on the telephone to attempt to resolve the matter in good faith within ten (10) business days of the initial request of either Party to meet.

B. In the absence of resolution of the matter in accordance with Article 14.A., the aggrieved Party may provide a notice of default to the other Party in writing. Upon receipt of such notice of default, the defaulting Party will either work diligently and cooperatively with the non-defaulting Party to correct such default or present sufficient evidence that a default does not exist or is not the fault of the defaulting Party. If such default will continue for a period of sixty (60) days after such notices, either Party may, at its sole discretion and option, terminate this Agreement in full if the default pertains to all poles, or, if Licensee is the defaulting Party, Licensor may deny future Attachments and/or remove the Attachments of Licensee to which the default pertains at Licensee's expense. Notwithstanding the foregoing, the cure periods may be extended upon mutual agreement of the Parties if a cure is not reasonably possible within the time frames specified above.

C. Without limiting the effect of the immediately preceding paragraph, if after reasonable notice, Licensee will default in the performance of any work it is obligated to do under this Agreement, the Licensor may elect to do such work, and the Licensee will reimburse the Licensor for the cost thereof. Licensor will notify the Licensee in advance of its intent to do the work and the approximate cost of doing such work. Failure on the part of the Licensee to make

such a payment, as set forth in Article 19 herein, will, at the election of the Licensor, constitute a default under Section B of this Article 14.

ARTICLE 15 – RIGHTS OF OTHER PARTIES

A. If Licensor, prior to the execution of this Agreement, received or conferred upon others, not parties of this Agreement (“Outside Parties”), by contract or otherwise, rights or privileges to attach to, and/or reserve space on any of its Poles covered by this Agreement, nothing herein contained will be construed as affecting said rights or privileges with respect to existing Attachments of such Outside Parties, which Attachments will continue in accordance with the present practice. All future Attachments of such Outside Parties will be in accordance with the requirements of the following paragraph, except where such Outside Parties have, by agreements entered into prior to the execution of this Agreement, acquired enforceable rights or privileges to make Attachments which do not meet such space allocations. Licensor will derive all of the revenue accruing from such Outside Parties. Any contractual rights or privileges of Outside Parties recognized in this paragraph will include renewals of or extensions of the term (period) of such contracts.

B. In the event any Pole or Poles of Licensor to which Licensee has made its Attachments would, but for the Attachments of Licensee, be adequate to support additional facilities desired by Licensor, Licensor’s subsidiary or affiliate, or by a Joint User with whom Licensor has a prior agreement and which Joint User is either occupying space or has requested to attach or reserve space on such Pole(s) prior to the placement of Licensee’s Attachment on such Pole(s), then Licensor will notify Licensee of any changes necessary to provide an adequate Pole or Poles and Licensor or Joint User will reimburse Licensee for the incremental costs thereof. Should Licensee submit a request to make a new Attachment on a Pole that a Joint User is not already attached to but on which the Joint User has reserved space, Licensor will provide notice of such space reservation to Licensee, provided that Licensor has such knowledge on or prior to the date of Licensee’s Attachment request.

C. If Licensor desires to confer upon Outside Parties, by contract or otherwise, rights or privileges to attach to any of its Poles covered by this Agreement, it will have the right to do so, provided all attachments of such Outside Parties are made in accordance with the following: (1) such attachments will be maintained in conformity with the requirements of Specifications, (2) such attachments will not be located within the space allocation of Licensee and (3) such Attachments will not interfere with Licensee’s Attachments. Licensor will derive all of the revenue accruing from such Outside Parties.

ARTICLE 16 – ASSIGNMENT OF RIGHTS

The rights conferred by this Agreement may be transferred by the Licensee to any successor in interest that has or is contemporaneously granted a franchise by the applicable franchise authority upon thirty (30) days written notice to the Licensor. Except as otherwise provided in this Agreement, including the immediately prior sentence, Licensee will not assign or otherwise dispose of this Agreement or any of its rights or interests hereunder, or in any of the Licensed Poles, or the Attachments or rights-of-way covered by this Agreement, to any firm, corporation or individual, without the written consent of the Licensor, which consent will not be unreasonably withheld or delayed, except to the United States of America or any agency thereof; provided, however, that nothing herein contained will prevent or limit the Licensee’s right to mortgage any or all of its property, rights, privileges, and franchises, or lease or

transfer any of them to another corporation organized for the purpose of conducting a business of the same general character, or to enter into any merger or consolidation; and, in case of the foreclosure of such mortgage or in case of lease, transfer, merger, or consolidation, its rights and obligations hereunder will pass to, and be acquired and assumed by, the purchaser at foreclosure, the transferee, lessee, assignee, merging or consolidating company, as the case may be; and provided further that, subject to all of the terms and conditions of this Agreement.

ARTICLE 17 – WAIVER OF TERMS OR CONDITIONS

The failure of either Party to enforce or insist upon compliance with any of the terms or conditions of this Agreement will not constitute a general waiver or relinquishment of any such terms or conditions, but the same will be and remain at all times in full force and effect.

ARTICLE 18 – PAYMENT OF TAXES

Each Party will pay all taxes and assessments lawfully levied on its own property upon said Licensed Poles, and the taxes and the assessments which are levied on said Licensed Poles will be paid by the owner thereof, but any tax, fee, or charge levied on Licensor's Poles solely because of their use by the Licensee will be paid by the Licensee, except for any such tax, fee, or charge levied by Licensor, excluding any tax, fee, or charge hereunder or any business use tax related to franchise or franchise agreement.

ARTICLE 19 – BILLS AND PAYMENT FOR WORK

A. Upon the completion of work performed hereunder by either Party, the expense of which is to be borne wholly or in part by the other Party, the Party performing the work will present to the other Party within ninety (90) days after the completion of such work an itemized statement of the costs, and such other Party will, within sixty (60) days after such statement is presented, pay to the Party doing the work such other Party's proportion of the cost of said work.

B. All amounts to be paid by either Party under this Agreement will be due and payable within sixty (60) days after receipt of an itemized invoice. Except as provided in Article 19.C below, any payment not made within sixty (60) days from the due date will bear interest at the rate of 1.5% per month until paid, or if 1.5% exceeds the maximum rate allowed by law, then at the maximum rate allowed by law. If a Party bills the interest provided for in this paragraph but then receives a payment showing that the payment was timely made, the billing Party will write off and cancel the interest.

C. A Party receiving a bill may, in good faith and for good cause, dispute the amount or adequacy of substantiation for the bill. In the event that a Party so disputes only a portion of a bill, then such Party will promptly pay the undisputed amount. In the event of such dispute, the Parties will meet, by telephone or in person, within ten (10) business days of a dispute being raised to discuss the disputed item and establish a procedure for addressing the disputed amount in accordance with this Agreement. Upon resolution of the dispute, if the amount and substantiation were correct and sufficient, interest will be paid on the unpaid balance from the date of the initial bill at the rate of 1.5% per month until paid, or if 1.5% exceeds the maximum rate allowed by law, then at the maximum rate allowed by law; but, if the amount was not correct or substantiation was not sufficient, no interest will be payable unless the amount determined to be correct is not paid within sixty (60) days of receipt of substantiation and

determination of the correct amount, in which case interest will be payable for the period beginning after the end of such sixty (60) day period.

D. Except as to the rental fees, the fees specified in this Agreement will be subject to an annual adjustment equal to the change in the most recent twelve month's Handy-Whitman Index for the South Atlantic Region, Account 364, Poles, Towers and Fixtures.

ARTICLE 20 – NOTICES

A. Except as otherwise provided in this Agreement, all notices and writings will be made to the people ("Contact Person(s)") identified below, who from time to time may be changed by written notice.

B. By written notice pursuant hereto, a Party may from time to time specify a person in lieu of the person designated in Section A above to receive notices or writings with respect to specified matter(s) and/or geographic area(s), in which case such notices or writings will be sent to that person as to such matter(s) and area(s).

C. Response to any notice or Application will be made to the sender rather than to the person designated in Section A or B above.

D. Unless otherwise provided in this Agreement, any notice will be in writing, which may, when mutually agreeable, include preservable and traceable electronic means, such as email or facsimile.

E. A second copy of any notice given under Article 14 or Article 22 of Agreement will be given to the following persons, who may from time to time be changed by written notice:

If to Licensor:

City of Grantville
Attn: City Manager
123 LaGrange St.
Grantville, GA 30220
770-583-2289

With a copy to:

Electric Cities of Georgia
Christine Carling
1470 Riveredge Parkway NW
Atlanta, GA 30328
770-919-6308
ccarling@ecoga.org

If to Licensee:

New Cingular Wireless PCS, LLC
Attn: Tower Asset Group- Lease Administration
Re: Cell Site #: _____; Cell Site Name: _____
Fixed Asset #: _____; State Where Site Located: GA
575 Morosgo Drive NE
Atlanta, GA 30324

With a copy to:
New Cingular Wireless PCS, LLC
Re: Cell Site #: _____; Cell Site Name: _____
Fixed Asset #: _____; State Where Site Located: GA_
AT&T Legal Department – Network
208 S. Akard Street,
Dallas, TX 75202-4206

F. In the event of the need for a temporary power shut-down, Licensor's authorized field personnel will contact Licensee at 1-800-638-2822 or other telephone number provided by Licensee and follow the instructions prior to working within one (1) foot of Licensee's equipment which emits RF.

G. The Parties will develop and maintain a joint form designating the people to whom notices will be given pursuant to the foregoing.

Except as otherwise noted, all notices, requests, demands and other communications hereunder will be in writing and will be delivered personally with a receipt evidencing delivery, sent by nationally recognized overnight courier, in each case addressed to the appropriate Party at the address for such Party shown above or at such other address as such Party will have previously designated by written notice delivered to the Party giving such notice. Except as otherwise permitted, any notice given in accordance herewith will be deemed to have been given and received when delivered to the addressee, which delivery may be evidenced by signed receipt of the addressee given to the courier or postal service

ARTICLE 21 – RESOLUTION OF CERTAIN DISPUTES

A. In the event of a dispute regarding any compliance or non-compliance with the provisions of Article 3 of this Agreement, including which Party, if any, is responsible for any non-compliance and what corrective action, if any, is necessary or appropriate to remedy any such non-compliance, then the Parties will each arrange for a representative to make a joint field visit to the Pole location to investigate whether a violation exists and if so, any corrective action needed and the Party or Parties responsible. The Parties will make a diligent and good faith effort to resolve such disputes at the local level by the Parties' respective local engineers and local managers.

B. If the Parties are unable to resolve any such dispute at the local level, then either Party may submit the matter for resolution to a "Referee," as defined below, for binding resolution. A matter will be submitted to the Referee by sending a letter (by mail or hand-delivery) to the Referee, with a copy provided to the other Party's representative who was involved in the attempt to resolve the dispute and the other Party's representative designated pursuant to Article 21.A or Article 21.B before or concurrently with the transmission of the letter to the Referee. The letter will include a summary of the dispute and will designate the Party's Contact Person for the dispute. The other Party will promptly respond with a letter similarly sent and copied that provides such Party's summary of the dispute and designates such Party's Contact Person for the dispute.

C. If the Parties mutually agree to do so, instead of proceeding under Section B above, the Parties may submit any dispute to the Referee by jointly sending the Referee a letter that includes a summary of the dispute and designates each Party's Contact Person for the dispute.

D. The Referee will make such investigation as deemed appropriate in his or her discretion, which will include hearing from each Party's Contact Person. The Referee may, but is not required to, engage in such other procedures or hearing as the Referee deems appropriate. The Parties will cooperate with the Referee.

E. The Referee will promptly issue a binding decision (to the extent permitted by law) in writing to the Parties, from which there will be no appeal. The Party whose position is not upheld by the Referee (which determination may be made by the Referee if requested to do so) will be required to pay for the Referee's fees and expenses. If both Parties' positions are upheld in part, they will share the Referee's fees and expenses equally. The Parties agree to be bound to pay the Referee's fees and expenses as provided herein.

F. The Referee will be appointed as follows:

1. Each Party will appoint an outside engineer or other qualified person and these two (2) appointees will appoint a third outside engineer or other qualified person (the "Referee") to serve as the Referee.

2. In the event that the two (2) appointees are unable within fourteen (14) days to agree upon a third outside engineer or other qualified person who is willing and able to serve as the Referee, then the Referee will be appointed as follows: Three (3) names will be blindly drawn from the list of persons then comprising the NESC committee whose work is most closely related to the dispute (e.g., Clearances Committee or Strength and Loading Committee), or such other group as may be mutually agreed upon. Each Party will strike one such name and the remaining person will serve as the Referee. If the Parties strike the same name, then the Referee will be selected from the remaining two (2) names by coin toss. If the NESC committee member so selected is unwilling or unable to serve as Referee, then this procedure will be repeated (starting with the blind drawing of three different names as provided above) as necessary until a Referee is selected who is willing and able to serve as Referee. If all committee member names of the NESC committee first selected are exhausted without a Referee being appointed who is willing and able to serve as Referee, then the Parties will repeat the above-described procedure with the next NESC committee whose work is most closely related to the dispute, and so on until a Referee is selected who is willing and able to serve as Referee.

G. Nothing herein will preclude the Parties from entering into any other mutually agreeable dispute resolution procedure or from changing by mutual written agreement any aspect of the foregoing procedures. Without limiting the generality of the foregoing, the Parties may by mutual written agreement remove, replace or appoint a Referee at any time.

H. The Parties agree, that if any dispute arising under this Agreement cannot be resolved at lower levels, communications between the following will be permitted and engaged in, in good faith on an expedited basis: Between a responsible senior officer with settlement authority of Licensor and a responsible manager with settlement authority of Licensee; and, if not resolved by them, between such persons' superiors, if any. If either Licensor or Licensee reorganizes or changes titles, the equivalent person for such Party will perform the above functions.

I. Except for disputes subject to the Referee procedure set forth herein, if a dispute arising under this Agreement is not resolved by the intercompany communications in Section H within

forty-five (45) days, the dispute will be resolved in a mediation process at a mutually agreeable location in the venue where the poles subject to the dispute are located. In the event that such dispute is not resolved within ninety (90) calendar days following the first day of mediation, either Party may initiate litigation. The foregoing obligations to engage in intercompany communications and mediation are an essential and material part of this Agreement and ones that are legally binding upon them; in case of a failure of either party to follow the foregoing dispute resolution process, the other may seek specific enforcement of such obligation in any courts having jurisdiction of this Agreement.

ARTICLE 22 – TERM OF AGREEMENT

A. This Agreement will continue in full force and effect for ten (10) years from the Effective Date (Initial Term), and will automatically renew for 5 year terms thereafter unless terminated in accordance herewith. Either Party may terminate the Agreement by giving to the other Party one (1) years' notice in writing of intention to terminate the Agreement one (1) year prior to the end of the Initial Term. Notwithstanding the foregoing, this Agreement will continue in full force and effect for all existing Attachments during any negotiations of the Parties for a subsequent agreement.

B. Upon final termination of this Agreement in accordance with any of its terms, Licensee will, within one-hundred eighty (180) days, remove all its Attachments from all Poles. If not so removed, Licensor will have the right to remove and dispose of all of Licensee's Attachments without any liability or accounting therefore. Licensee will reimburse Licensor for any and all costs incurred by Licensor in the removal of Licensee's Attachments as detailed above. In the event that Licensee has not reimbursed Licensor within sixty (60) days of invoicing following Licensor's removal of said Attachments, then Licensor may pursue one or more of the remedies contained in Article 14, including making demand on the Security Instrument described in Article 25.

C. Termination of this Agreement will not relieve either Party from fulfilling any and all of its obligations that accrued while the Agreement was in effect.

D. During the term of this Agreement or upon termination of this Agreement, each Party will have reasonable access to those portions of the other Party's books, construction standards, and records, as may be necessary to resolve a material issue or concern regarding the other Party's compliance with its obligations under this Agreement. Such access will be granted upon reasonable notice and only during regular business hours.

ARTICLE 23 – EXISTING CONTRACTS

All existing joint use or pole attachment license agreements between the Parties, and all amendments thereto are by mutual consent hereby abrogated and superseded by this Agreement except with respect to amounts owed, late payment penalties and interest and remedies available for collection of such amounts by either party under any such existing agreements.

Nothing in the foregoing will preclude the Parties to this Agreement from entering such supplemental operating routines or working practices as they mutually agree in writing to be necessary or desirable to effectively administer the provisions of this Agreement.

ARTICLE 24 – LICENSOR SYSTEM FINANCING OR SALE OF SYSTEM

This Agreement and any amendment thereof will be effective subject to the condition that, during any period in which the Licensor has outstanding debt or other financing obligations respecting its Poles or its electric distribution system, this Agreement will be subject to the terms and conditions related to such financing. Licensor, without the consent of the Licensee, may enter into or issue debt or other financing obligations from time to time related to its Poles or its electric distribution system with terms and conditions, including covenants that affect Licensee's rights hereunder, that are reasonably required by the counterparties to such transactions or the purchasers of such debt or other financing obligations. Licensor, without the consent of the Licensee, may at any time sell or otherwise transfer ownership of all or any part of its Pole or electric distribution system, and in conjunction therewith, may terminate this Agreement or assign it to the purchaser or transferee in whole or in part.

ARTICLE 25 – LIABILITY AND INDEMNIFICATION

A. Except as set forth below, Licensee assumes sole responsibility for all injuries and damages caused, or claimed to have been caused, by Licensee, its employees, agents, representatives or contractors. Notwithstanding the foregoing, Licensee will have no liability to the Licensor for injuries and damages (a) caused by, through or as a result of the negligence of the Licensor; (b) caused by, through or as a result of the wanton misconduct of the Licensor; or (c) caused by, through or as a result of the facilities or activities of any third party (or parties) attached whose cables, wires, appliances, equipment or facilities are attached to the same Poles as Licensee's cables, wires, appliances, equipment or facilities.

B. Accordingly, without limiting the effect of the provision of the immediately preceding paragraph, and except as set forth below, Licensee expressly agrees to indemnify, defend and save harmless the Licensor, its governing body, officers, employees, agents, representatives and contractors from all claims, demands, actions, judgments, loss, costs and expenses (collectively, "Claims") caused or claimed to have been caused by, Licensee, its employees, agents, representatives or contractors, including with respect to (a) damage to or loss of property (including but not limited to property of the Licensor or Licensee); (b) injuries or death to persons (including but not limited to injury to or death of any Licensee employees, contractors or agents, or members of the public); (c) any interference with the television or radio reception of, or with the transmission or receipt of telecommunications by, any person which may be occasioned by the installation or operation of Licensee's cables, wires, appliances, equipment or facilities; (d) any injuries sustained and/or occupational diseases contracted by any of the Licensee's employees, contractors or agents of such nature and arising under such circumstances as to create liability therefore by Licensee or the Licensor under any applicable Worker's Compensation law, including also all claims and causes of actions of any character which any such contractors, employees, the employers of such employees or contractors, and all persons or concerns claiming by, under or through them or either of them may have or claim to have against the Licensor resulting from or in any manner growing out of any such injuries sustained or occupational diseases contracted; it being understood, however, that Licensee will have no liability to the Licensor for injuries and damages (a) caused by, through or as a result of the negligence of the Licensor; (b) caused by, through or as a result of the wanton misconduct of the Licensor; or (c) caused by, through or as a result of the facilities or activities of any third party (or parties) whose cables, wires, or facilities are attached to the same Poles as Licensee's cables, wires, or facilities. In any matter in which Licensee will be

required to indemnify the Licenser hereunder, Licensee will control the defense of such matter in all respects, and the Licenser may participate, at its sole cost, in such defense. The Licenser will not settle or compromise any matter in which Licensee is required to indemnify the Licenser without the prior consent of Licensee.

C. To the extent permitted by law, the Licenser agrees to assume liability and be responsible for the payment of any sum or sums of money to any persons whomsoever on account of any Claims arising or claimed to have arisen by, through or as a result of the Licenser's negligent acts or omissions or the Licenser's intentional or wanton misconduct. Licenser will have no liability to the Licensee for injuries and damages (a) caused by, through or as a result of the negligence of the Licensee or its contractors or agents; or (b) caused through or as a result of the wanton misconduct of the Licensee or any of its contractors, agents, representatives or assignees. Nothing contained herein will constitute a waiver of the defense of sovereign immunity in favor of the Licenser.

D. Insurance. In the event Licensee's franchise agreement requires Licensee to insure the franchise authority, the Insurance requirements set forth in Article 25.E herein will not apply to Licensee.

E. In the event Licensee is not required to insure the franchise authority, pursuant to the franchise agreement, Licensee, and any contractors of Licensee while working hereunder, will contract for and maintain in effect throughout the period during which Licensee maintains Attachments on any Poles insurance that meets the amounts set forth in subsections (1) through (3) below. Failure to provide and maintain the required insurance coverage will constitute a Default under this Agreement, in which event Licenser will have the right to pursue any and all of remedies set forth in this Agreement.

1. Worker's Compensation insurance meeting statutory requirements, covering all employees of Licensee who will perform any work on Poles or property owned or controlled by Licenser, including easements and rights-of-way, whether or not such insurance is required by law. If any employee is not subject to the Worker's Compensation laws of the state wherein work is performed, Licensee will extend said insurance to such employee as though said employee were subject to such laws.

2. Commercial general liability insurance covering all operations under this Agreement, including erection, installation, maintenance, Rearrangement and removal of Licensee's Attachments, for bodily injury including death and for property damage of \$2,000,000 per occurrence and in the aggregate and \$2,000,000 products and completed operations aggregate.

3. Automobile liability insurance including self-propelled vehicles which may be used in connection with this Agreement, whether owned, non-owned, or hired, with combined single limit for bodily injury and property damage of \$1,000,000 for each accident.

4. The policies required hereunder will be and issued by such carrier will rated at least V-AII by AM Best.

- (a) Licenser, its governing body, officers, employees, and agents will be included as additional insured on each required general and auto liability policy

only with respect to liability arising from Licensee's operation in conjunction with this Agreement; and

(b) To the extent allowed by law, Licensee agrees to release and will require its insurers (by policy endorsement if needed) to waive their rights of subrogation against Licensor, its governing body, officers, employees, and agents for loss under the policies of insurance described herein; and

(c) Licensee will furnish Licensor certificates evidencing such insurance within thirty (30) days of the Effective Date of this Agreement and will provide Licensor with copies of any renewal certificates promptly after they become available.

(d) Notwithstanding the above, if Licensee is authorized to operate as a self-insured entity under the laws of the State of Georgia, Licensee may provide self-insurance to meet any of the requirements of this Article 25.E, upon terms and conditions satisfactory to Licensor.

F. **SECURITY INSTRUMENT.** Licensee will furnish and maintain throughout the term of this Agreement, and thereafter until all of the obligations of Licensee have been fully performed, a bond or other security instrument ("Security Instrument") satisfactory in form and content to Licensor in substitution therefore, to guarantee the payment of any sums which may become due to Licensor or an Licensor Agent for Pole Attachment Rental Fees, inspections, inventories, Make Ready Costs, Unauthorized Attachment Fees, for work performed for the benefit of Licensee under this Agreement, including the removal of Attachments upon termination of this Agreement, for any expense that may be incurred by Licensor or an Licensor agent because of any Default of Licensee, or for any other expense that is to be borne by Licensee under this Agreement. The amount of said Security Instrument, which amount will be maintained throughout the term of the Agreement and thereafter until all of the obligations of Licensee have been fully performed, will be equal to ten thousand US dollars (\$10,000), or twenty-five dollars (\$25) per Attachment, whichever is larger. The amount of the Security Instrument may, in Licensor's discretion, be adjusted if Licensee purchases, acquires, or obtains a controlling interest in additional broadband or other facilities within Licensor's service territory not currently covered by this Agreement which results in a significant increase in the number of Attachments. Any such adjustment will not exceed twenty-five dollars (\$25) per new Attachment. Failure to provide and maintain the aforementioned Security Instrument will be deemed a Default under this Agreement, in which event Licensor will have the right to pursue any and all remedies set forth in this Agreement and at law or equity. The furnishing of such Security Instrument will not affect, limit, diminish or otherwise reduce any obligations of Licensee under this Agreement.

G. Following the completion of the Initial Safety Inspection, the correction of the identified violations, and if the Licensee is in material compliance with all other terms and conditions of the Agreement, the amount of the Security Instrument will be adjusted annually to an amount not to exceed the last annual Pole rental invoice received by the Licensee.

ARTICLE 26 - COMPLIANCE WITH LAWS; CHANGE OF LAW

A. Applicable Law. Both Parties will comply with all applicable laws and regulations.

B. Change of Law. In the event that any legislative, regulatory, judicial, or other action affects the rights or obligations of the Parties, or establishes rates, terms or conditions for the construction, operation, maintenance, repair or replacement of small cells on city infrastructure or in the right of way, that differ, in any material respect from the terms of this Agreement (“New Law”), then either Party may, upon thirty (30) days written Notice, require that the terms of this Agreement be renegotiated to conform to the New Law. Such conformed terms will then apply on a going forward basis for all existing and new small cell installations, unless the New Law requires retroactive application, in which case such new terms will apply retroactively, as required by the New Law. In the event that the Parties are unable to agree upon new terms within 90 days after Notice, then the rates contained in the New Law will apply from the 90th day forward until the negotiations are completed, or a Party obtains a ruling regarding the appropriate conforming terms from a commission or court of competent jurisdiction.

ARTICLE 26 – CONSTRUCTION

This Agreement was drafted by all Parties hereto and is not to be construed against any party. Neither the negotiations of the language of this Agreement nor any prior drafts of this Agreement or the inclusion or exclusion of any language from prior drafts will be admissible or probative as to the meaning of this Agreement.

ARTICLE 27 – REMEDIES CUMULATIVE

Unless otherwise provided in this Agreement, all remedies set forth in this Agreement are cumulative and in addition to any other remedies that may be available herein or at law or in equity, if any.

ARTICLE 28 – MISCELLANEOUS

A. Counterparts. This Agreement may be executed in multiple counterparts, and any one of such counterparts will be considered an original hereof.

B. Entire Agreement; Prior Agreements; Integration. This Agreement and its Exhibits set forth the entire understanding and agreement of the parties as to the subject matter herein, which is the attachment of small cell wireless antenna and equipment to poles. No other prior verbal or written agreements or understandings by and between the parties related to the subject matter contained herein will be effective and are hereby abrogated by, superseded by, or integrated into this Agreement. In the event of a conflict of any term and condition or provision among this Agreement, its Exhibits, and the Attachment permits, the following will control in order of precedence: This Agreement; Exhibits to this Agreement; any Ordinances currently in effect; and Attachment Permits.

C. Severability. In case any one or more of the provisions of this Agreement will for any reason be held to be illegal or invalid by a court of competent jurisdiction, it is the intention of each of the Parties hereto that such illegality or invalidity will not affect any other provision hereof, but this Agreement will be construed and enforced as if such illegal or invalid provision had not been contained herein, and this Agreement will be construed to adopt, but not to enlarge upon, all the applicable provisions of applicable law, and, if any provisions hereof

conflict with any provision of applicable law, the latter as in effect and as interpreted by the applicable courts will prevail in lieu of any provision hereof in conflict or not in harmony therewith.

D. Force Majeure. As used in this Agreement "Force Majeure Event" means any act or event whether foreseen or unforeseen, that meets all of the following tests:

1. The act or event prevents a party (the "Nonperforming Party"), in whole or in part, from performing its obligations under this Agreement or satisfying any conditions to the other party's obligations under this Agreement.
2. The act or event is beyond the reasonable control of and not the fault of the Nonperforming Party.
3. The Nonperforming Party has been unable to avoid or overcome the act or event by the exercise of due diligence.

E. Despite the preceding definition of a Force Majeure Event, a Force Majeure Event excludes economic hardship, changes in market conditions or insufficiency of funds.

F. In the event of a Force Majeure Event affecting Licensor's Poles, the Parties' obligations hereunder are suspended for a period of time reasonably appropriate to the Force Majeure Event to the extent performance hereunder adversely affected.

G. Modifications; Amendments. No amendment or modification of this Agreement will be binding unless executed in writing by the Parties hereto.

H. Governing Law. Except to the extent that federal law, regulations, and/or agency orders control any aspect of this Agreement, the validity of this Agreement, the construction and enforcement of its terms, and the interpretation of the rights and duties of the parties will be governed by the laws of the State in which the subject poles are located.

I. Hazardous Materials. Licensor agrees to comply with applicable state and federal environmental laws and regulations including those governing hazardous materials and waste, and, warrants that it administers and enforces policies, practices and procedures sufficient to achieve such compliance with respect to its facilities.

IN WITNESS WHEREOF the Parties hereto have caused these presents to be executed in two counterparts, each of which will be deemed an original, and their corporate seals to be affixed thereto by their respective officers thereunto duly authorized, as of the Effective Date.

LICENSOR
City of Grantville

By: _____
Name:
Its:

Attest:

By: _____
Its:

[SEAL]

LICENSEE
NEW CINGULAR WIRELESS PCS, LLC

By: AT&T Mobility Corporation
Its: Manager

By: _____
Name:
Its:

Attest:

By: _____
Its:

[SEAL]

Exhibit 1 – Application to Attach

Licensee hereby requests permission pursuant to its Addendum to Pole Attachment License Agreement for Attachment of Wireless Facilities to make new Attachment(s) to Pole as shown on the attached construction plans and drawings. The attached plans and drawings show the Pole Licensee desires to attach to, the number and character of Attachments existing and proposed, any Rearrangements requested with respect to existing Attachments, any relocations or replacements of existing Pole requested, the heights of all points of attachment, all mid-span clearances, any new Pole placement requested, pole loading analysis report, and completed Radio Frequency Emission Certificate. Should additional information be required by the Electric Provider for verification of compliance with the NESC or other applicable standards, the Licensee will provide such information. The table below provides detailed information regarding this request.

LICENSEE NAME:			
Project		Proposed Attachments	
Request #		New	Modified
Request		Power Space	in.
Name		Communications Space	in.
Phone		Common Space	in.
E-Mail			
Estimated Construction Dates			
Start		Finish	
Signature			
Include Attachments above the top of the Pole and in the Communications Worker's Safety Zone			

Please advise Licensee as to whether or not these Wireless Facilities Attachments will be permitted and if necessary provide an estimate for any additional costs that Licensee may be required to pay as Make Ready Work. If Make Ready Work is required, upon receipt of Electric Provider supplied Make Ready Estimate, the Licensee will provide notice to Electric Provider of either approval of the cost estimate or that Licensee will not undertake to make these Attachments. Upon receipt by Electric Provider of Licensee's notice of estimate approval of Make Ready Costs, the Electric Provider will proceed with Make Ready Work.

ELECTRIC PROVIDER			
Response Date		Make Ready Construction Required?	Yes
Name			No
Phone		Make Ready Construction Estimate	\$
Email			
Signature		Permit #	
Request	Approved	Reason for Denial:	
	Denied		

Capitalized terms used in this request, but not defined, have the meaning set forth in the applicable Addendum to Pole Attachment License Agreement for Attachment of Wireless Facilities or Pole Attachment License Agreement.

Exhibit 2 – Annual Attachment Fee

Wireless Facilities Attachments

The Adjustment Payments for Wireless Facilities will be calculated on a “per foot” basis. For purposes of calculating such Adjustment Payments for Wireless Facilities, every twelve inches (12”) of vertical space, or any part thereof, of each Wireless Facility component which is attached to the Pole, exclusive of riser and/or conduit, regardless of placement location, will constitute one (1) attachment. For example, if Licensee’s Wireless Facility takes up thirty inches (30”) of vertical space on the Pole, such Wireless Facility will be considered as three (3) attachments for purposes of determining the Adjustment Payment for such Wireless Facility.

Term	Rental Fee	Invoice Date
Jan. 1, 2019 – Dec. 31, 2019	\$16.50	Dec. 1, 2019
Jan. 1, 2020 – Dec. 31, 2020	\$16.50	Dec. 1, 2019

For years beginning 2021, the annual Rental Fee per Attachment will be adjusted by applying the annual change for account 364 for the South Atlantic Region from the latest version of the Handy Whitman Index.

Exhibit 3 Radio Frequency Emissions Certification

The Effective Isotropic Radiated Power ("EIRP") of the Wireless Facilities will comply with Part 15 of the FCC Rules and radio frequency exposure from the Wireless Facilities will comply with Sections 1.1307(b) and 1.1310 of the FCC's Rules, as clarified by the FCC's *OET Bulletin 65*, latest revisions ("RF Exposure Rules").

Will the Wireless Facilities that are the subject of the accompanying Application to Attach, dated _____, as installed, comply fully with the RF Exposure Rules for General Population/Uncontrolled Environments as specified by the Federal Communications Commission at 47 C.F.R. §§1.1307(b) and 1.1310 (or its successor regulation) and clarified by the FCC's *OET Bulletin 65*, latest revision, ?

___ Yes

___ No

Certification:

I certify that: (i) I am a qualified/certified RF Engineer with experience regarding radio frequency emissions; (ii) I have performed the analysis specified in 47 C.F.R. § 1.1310 of the FCC's rules and *OET Bulletin 65* for each and every one of the Wireless Facilities Attachments covered in the Request for Permission to Attach Wireless Facilities, dated _____, and (iii) the answer given above is true.

Signature

Print Name

License Number

Exhibit 4 – Approved Contractors

Exhibit 5 – ECG Specifications

[ATTACH SECTION 5 “JOINT USE AND CLEARANCES” OF THE
ELECTRIC CITIES OF GEORGIA INC. CONSTRUCTION ASSEMBLY SPECIFICATIONS]

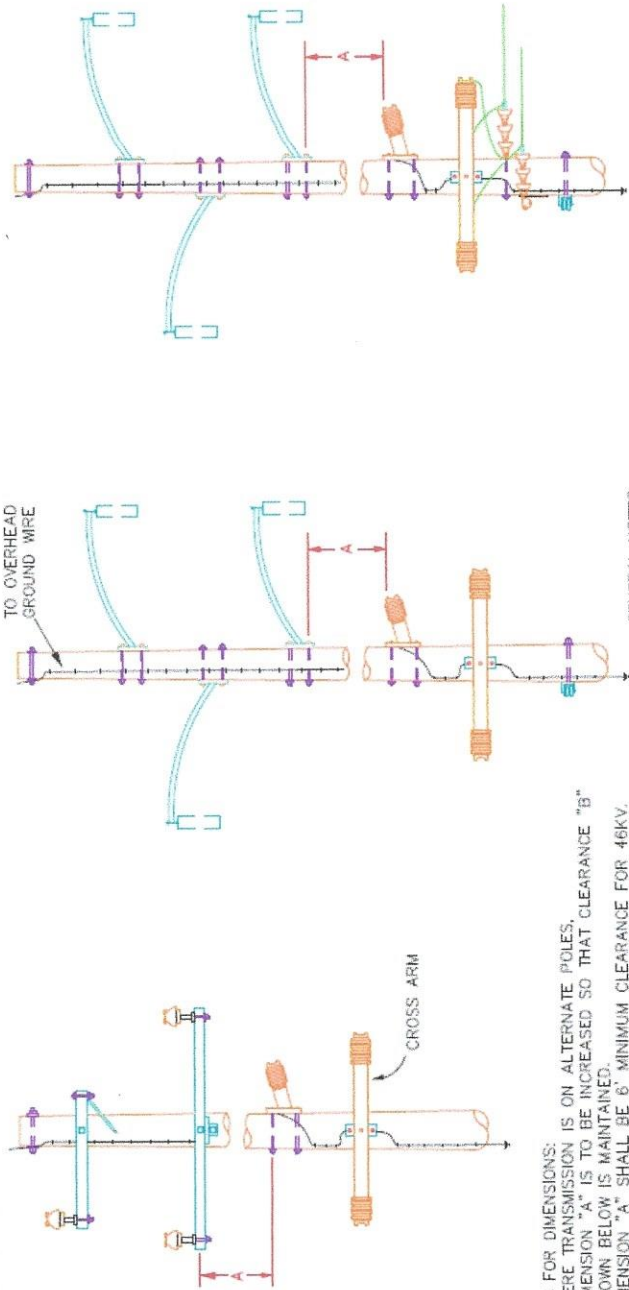

NOTES FOR DIMENSIONS:

1. WHERE TRANSMISSION IS ON ALTERNATE POLES, DIMENSION "A" IS TO BE INCREASED SO THAT CLEARANCE "B" SHOWN BELOW IS MAINTAINED.
2. DIMENSION "A" SHALL BE 6' MINIMUM CLEARANCE FOR 46KV.
3. DIMENSION "A" SHALL BE 10' MINIMUM CLEARANCE FOR 69KV.
4. DIMENSION "B" SHALL BE 11' MINIMUM CLEARANCE AT 120' FAHR. FOR 115KV AND BELOW.
5. DIMENSION "B" SHALL BE 13' MINIMUM CLEARANCE AT 120' FAHR. FOR 230KV.

- GENERAL NOTES:**
1. ALL HARDWARE SHALL BE BONDED TO TRANSMISSION GROUND.
 2. BOND NEUTRAL TO TRANSMISSION GROUND. DO NOT INSTALL ADDITIONAL GROUND LEAD.

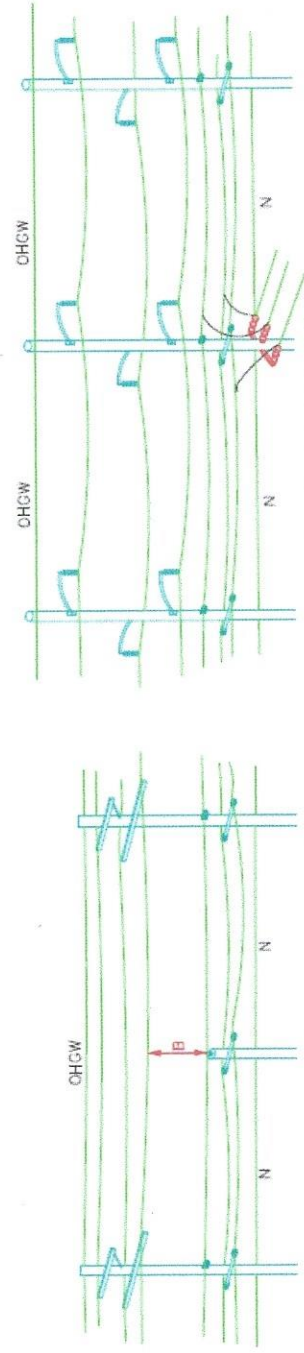

JOINT TRANSMISSION & DISTRIBUTION



DATE: OCTOBER, 1992

REVISIONS JULY, 2001
JANUARY, 2007

JU&C1

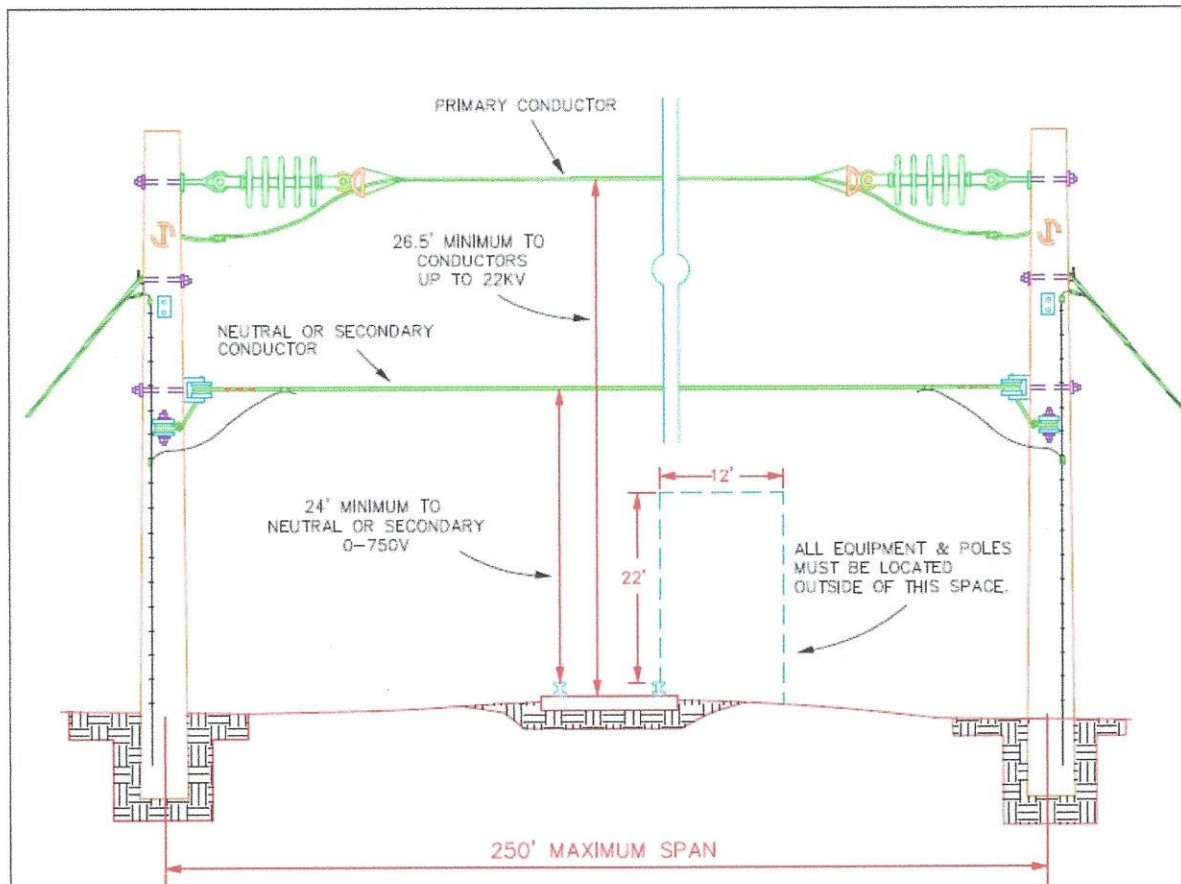

1. IF SPAN LENGTH EXCEEDS 250 FEET, CONDUCTOR CLEARANCE IS TO BE INCREASED 0.3 FEET FOR EACH 10 FEET SPAN LENGTH IN EXCESS OF THE 250 FEET.
2. CROSSINGS SHOULD BE MADE ON A COMMON SUPPORT STRUCTURE WHERE PRACTICAL COOPERATION BETWEEN THE PARTIES CONCERNED SHALL PREVAIL PROPER CLEARANCES.
3. EXCEPTIONS TO 12' HORIZONTAL SIDE CLEARANCE:
 - (a) A CLEARANCE OF NOT LESS THAN 8 FEET MAY BE ALLOWED WHERE NECESSARY IF THE SUPPORTING STRUCTURE IS NOT THE CONTROLLING OBSTRUCTION, PROVIDED SUFFICIENT SPACE FOR A DRIVEWAY IS LEFT WHERE CARS ARE LOADED.
 - (b) WHERE NECESSARY TO PROVIDE SAFE OPERATING CONDITIONS WHICH REQUIRE AN UNINTERRUPTED VIEW OF SIGNALS, SIGNS, ETC. ALONG TRACKS THE PARTIES CONCERNED SHALL COOPERATE IN LOCATING STRUCTURES TO PROVIDE THE NECESSARY CLEARANCE.
 - (c) AT INDUSTRIAL SIDINGS, A CLEARANCE OF NOT LESS THAN 8 FEET SHALL BE PERMITTED, PROVIDED SUFFICIENT SPACE IS LEFT WHERE CARS CAN BE LOADED OR UNLOADED.

RAILROAD CROSSING CONSTRUCTION CLEARANCES



DATE: OCTOBER, 1992

REVISIONS JULY, 2001

JANUARY, 2007

JU&C2

NOTES:

1. THIS 40" CLEARANCE ALSO APPLIES TO THE CLOSEST METAL PORTION OF ANY ONE SPOOL OR FOUR SPOOL RACKS.
2. IF THE BOTTOM OF THE CONDUCTOR BRACKET IS LESS THAN 10" FROM THE BOTTOM OF THE TRANSFORMER TANK, THEN THE 40" REQUIRED SPACE FROM THE BOTTOM OF THE CONDUCTOR SHALL SUPERCEDE THE 30" SPACE FROM THE BOTTOM OF THE TRANSFORMER TANK.
3. MESSENGER STRAND SHALL BE BONDED TO THE POLE GROUND, IF PRESENT.

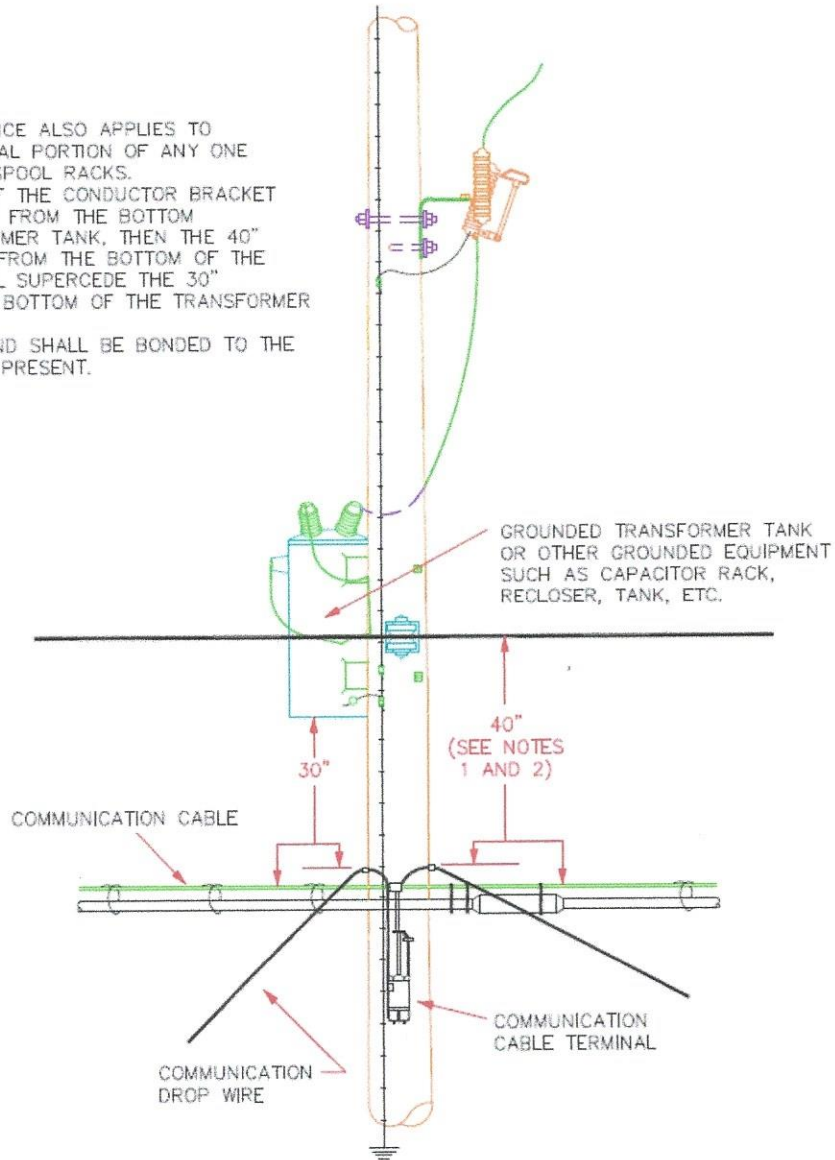

TRANSFORMER POLE



DATE: OCTOBER, 1992

REVISIONS JULY, 2001

JU&C3

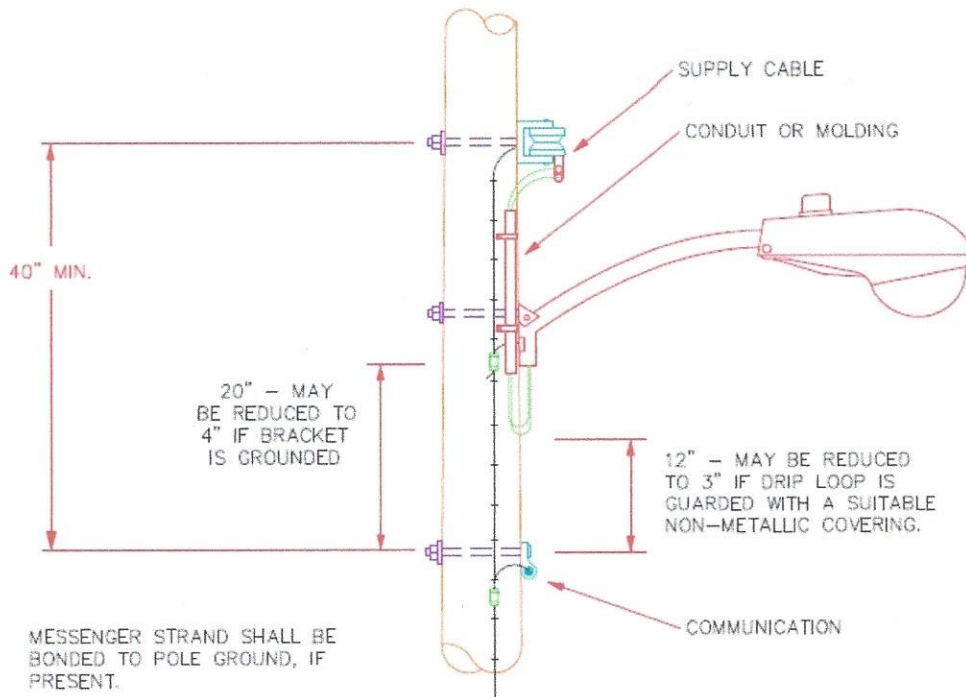

NOTES:

- 1.) LIGHT FIXTURE SHOWN IS SYMBOLIC ONLY. CLEARANCES SHOWN ARE APPLICABLE TO ANY TYPE FIXTURE USED.
- 2.) LOWEST PART OF LUMINAIRE SHALL BE NOT LESS THAN 15' OVER ROADS, STREETS, PARKING LOTS, OR ALLEYS.

C.A.T.V., TELEPHONE, OTHER SEPARATION FROM LUMINAIRES



DATE: OCTOBER, 1992

REVISIONS JULY, 2002

JU&C4

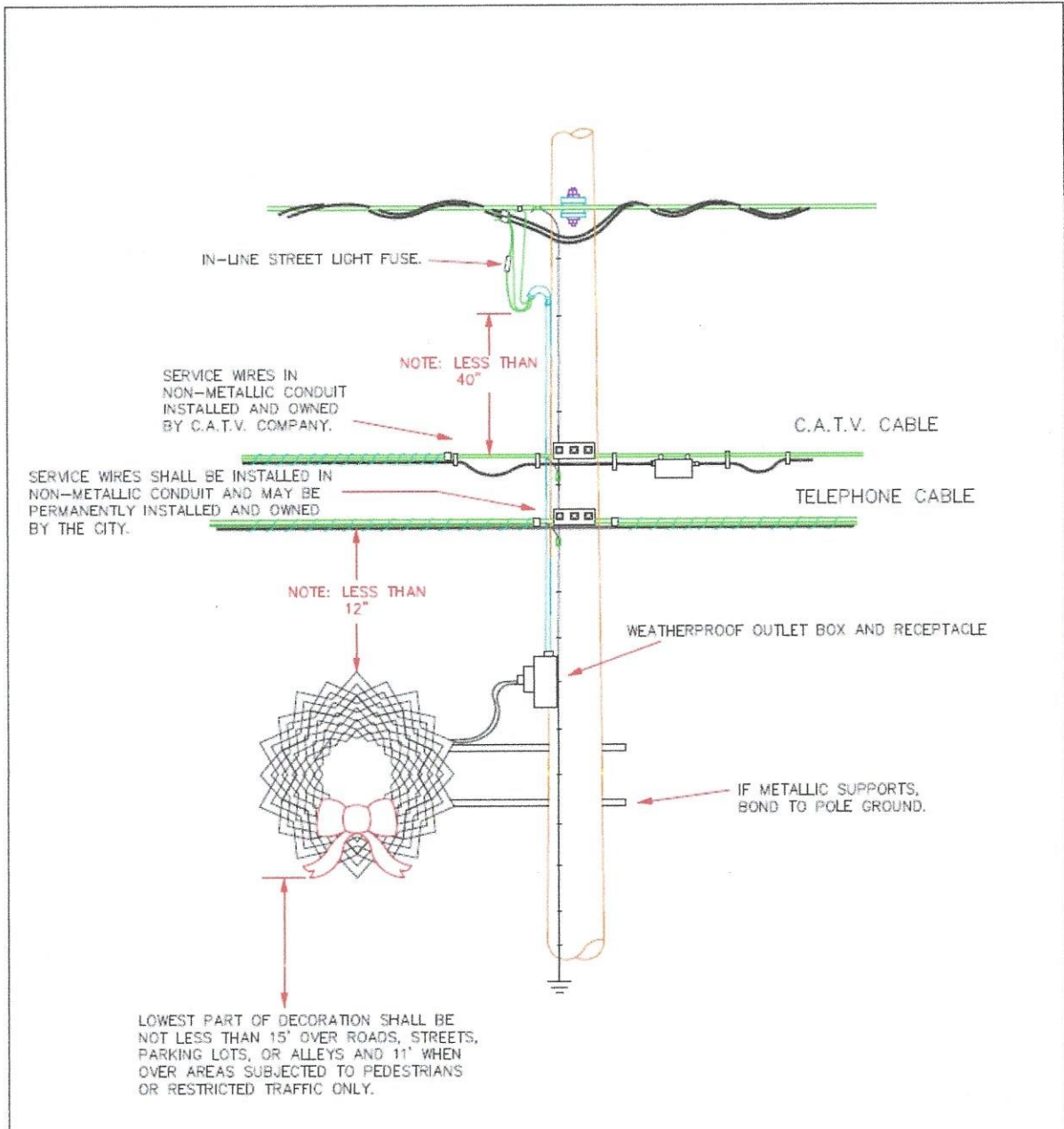

DECORATIVE ATTACHMENT INSTALLATION



REVISIONS JULY, 2001

DATE: OCTOBER, 1992

JU&C5

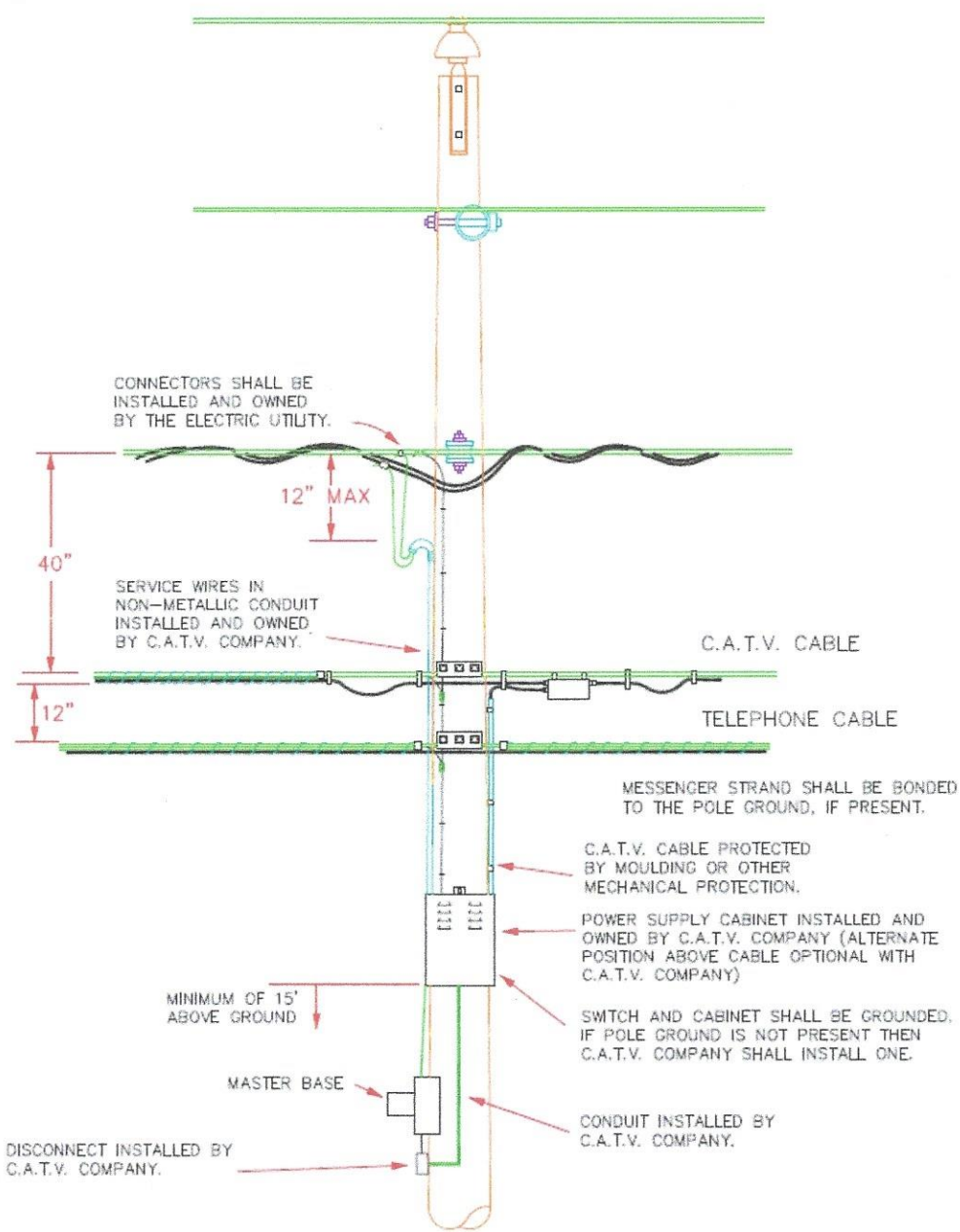

**COMMUNICATION/SIGNAL TYPE ATTACHMENT
C.A.T.V. POWER SUPPLY INSTALLATION**

	REVISIONS <u> JULY, 2001 </u> <hr/> <hr/>	<h1 align="center">JU&C6</h1>
DATE: <u> OCTOBER, 1992 </u>		

***COMMUNICATION/SIGNAL TYPE ATTACHMENT**

- TELEPHONE CABLE
- C.A.T.V. CABLE
- ALARM CABLE (FIRE, POLICE, WATER TOWER LEVEL, ETC.)
- TRAFFIC SIGNAL CONTROL CABLE
- TELEGRAPH CABLE
- PUBLIC OR PRIVATE COMMUNICATION CABLE

NOTES:

- 1.) WHEN C.A.T.V. AND TELEPHONE ARE ATTACHED TO POLE, C.A.T.V.'S PREFERRED POSITION IS ABOVE TELEPHONE (12" MIN.). IF OTHER COMMUNICATION/SIGNAL TYPE CABLES ARE ATTACHED TO POLE WITH C.A.T.V. AND/OR TELEPHONE, THEIR POSITION SHALL BE MUTUALLY AGREED UPON.
- 2.) 12" MIN. SPACING SHOULD BE MAINTAINED BETWEEN CABLES. C.A.T.V. AND TELEPHONE DROPS CAN BE LESS THAN 12" FROM OTHER CABLES. DROPS SHALL BE 40" BELOW POWER NEUTRAL OR SECONDARY AT POLE.
- 3.) ALL CABLES SHALL BE ON SAME SIDE OF POLE.
- 4.) MESSENGER STRAND SHALL BE BONDED TO POLE GROUND, IF PRESENT.

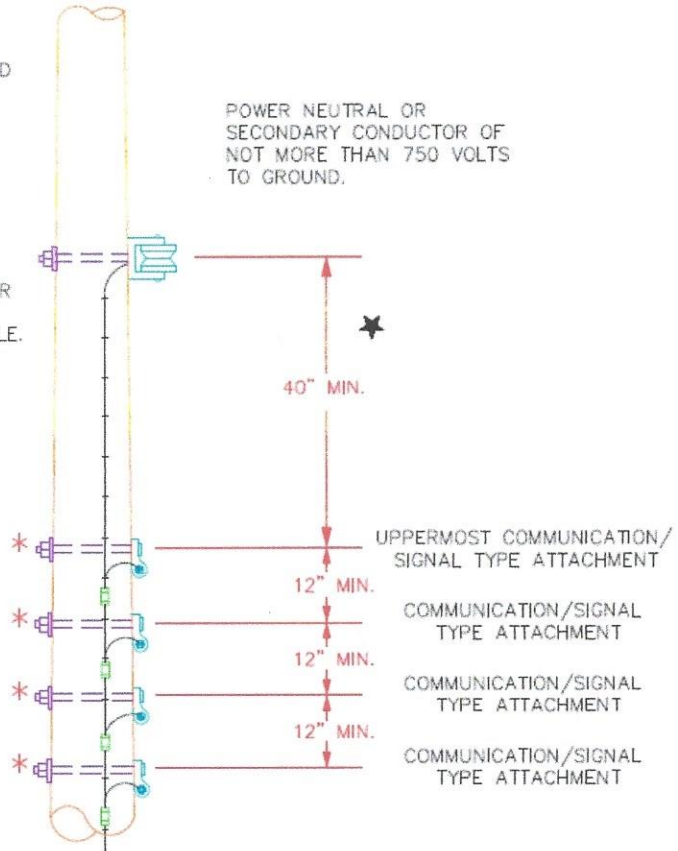

* FOR SUPPLY NEUTRAL ONLY, THIS MAY BE REDUCED TO 30".

MULTIPLE COMMUNICATION/SIGNAL TYPE ATTACHMENT



REVISIONS JULY, 2001

DATE: OCTOBER, 1992

JU&C7

FOOTNOTES TABLE 1:

1. Where the height of a building or other installation does not permit service drops to meet these values, the clearances over residential driveways only may be reduced to the following:

	<u>FEET:</u>
a. Service drops limited to 300 V to ground	12.5
b. Service drip loops limited to 300 V to ground	10.5
c. Service limited to 150 V to ground	12.0
d. Drip loops only of service limited to 150 V to ground	10.0

2. Where the height of a building or other installation does not permit service drops to meet these values, the clearances may be reduced to the following:

	<u>FEET:</u>
a. Service drops, including drip loops, limited to 300 V to ground	10.5
b. Service drops, including drip loops, limited to 150 V to ground	10.0

3. Spaces and ways subject to pedestrians or restricted traffic only are those areas where equestrians, vehicles, or other mobile units, exceeding 8ft. in height, are prohibited by regulation or permanent terrain configurations or are otherwise not normally encountered or reasonably anticipated.

4. Where a supply or communication line along a road is located relative to fences, ditches, embankments, etc., so that the ground under the line would not be expected to be traveled except by pedestrians, the clearance may be reduced to the following values:

	<u>FEET:</u>
a. Insulated communications cables, neutrals, guys, and multiplex supply cables limited to 150 V to ground	9.5
b. Multiplex supply cables limited to 300 V to ground	12.5

5. This clearance may be reduced to 13 ft. for communication conductors and guys.

6. Where this construction crosses over or runs along alleys, driveways, or parking lots, this clearance may be reduced to 15 ft.

7. For controlled impoundments, the surface area and corresponding clearances shall be based upon the design high water level. For other waters, the service area shall be that enclosed by its annual high water mark, and clearances shall be based on the normal flood level. The clearance over rivers, streams, and canals shall be based upon the largest surface area of any 1 mi. long segment, which includes the crossing. The clearance over a canal, river, or stream normally used to provide access for sailboats to a larger body of water shall be the same as that required for the larger body of water.

9. For the purpose of this rule, trucks are defined as any vehicle exceeding 8 ft. in height. Areas not subject to truck traffic are areas where truck traffic is not normally encountered or not reasonably anticipated.

10. Communication cables and conductors may have a clearance of 15 ft. where poles are back of curbs or other deterrents to vehicular traffic.

Note: Footnote 8 and 11 were intentionally omitted

FOOTNOTES TABLE 1: (cont'd)

12. Where the U.S. Army Corps of Engineers, or the state or the surrogate thereof has issued a crossing permit, clearance of that permit shall govern.
13. For controlled impoundments, the surface area and corresponding clearance shall be based upon the design high water level. For other waters, the surface area shall be that enclosed by its annual high water mark, and clearances shall be based upon the largest surface area of any one mile long segment that includes the crossing. The clearance of a canal, river or stream normally used to provide access for sailboats to a larger body of water shall be the same as required for the larger body of water.
14. Where an over water obstruction restricts vessel height to less than the following:

Surface Area (Acres)	Reference Vessel Height (Feet)
less than 20	16
20 to 200	24
200 to 2000	30
over 2000	36

The required clearances may be reduced by the difference between the reference vessel height given above and the over water obstruction height, except that the reduced clearance shall not be less than that required for the surface area on the line crossing side of the obstruction.

The vertical clearance shall be maintained with the conductor at final sag and at the following condition whichever results in the greater vertical sag:

1. 32° F, no wind, with radial thickness of ice of 1/4 inch for medium loading and no ice for light loading.
- Or
2. The maximum conductor for which the line is designed to operate, if greater than 120° F.(120° F for all neutrals)

Note:

All clearances shown are design clearances under specified conditions, not measured clearances under ambient conditions.

VOLTAGES ARE PHASE TO GROUND FOR EFFECTIVELY GROUNDED CIRCUITS				
NATURE OF SURFACE UNDERNEATH WIRES, CONDUCTORS, OR CABLES	INSULATED COMMUNICATION CONDUCTORS AND CABLE; MESSENGERS; GROUNDED GUYS; SYSTEM NEUTRAL	DUPLEX, TRIPLEX, & QUADRAPLEX CABLE WITH GROUNDED GUYS; GROUNDED NEUTRAL	OPEN WIRE SECONDARY CONDUCTORS	OPEN WIRE CONDUCTORS
	(IN FEET)	(IN FEET)	(IN FEET)	(IN FEET)
WHERE WIRES, CONDUCTORS, OR CABLE CROSS OVER OR OVERHANG				
1. TRACK RAILS OF RAILROADS.	23.5	24	24.5	26.5
2. ROADS, STREETS, AND OTHER AREAS SUBJECT TO TRUCK TRAFFIC. (SEE NOTE 9.)	15.5	16	16.5	18.5
3. DRIVEWAYS, PARKING LOTS, AND ALLEYS	15.5 (SEE NOTES 1 AND 6)	16 (SEE NOTES 1 AND 6)	16.5 (SEE NOTE 1)	18.5
4. OTHER LAND TRAVERSED BY VEHICLES SUCH AS CULTIVATED, GRAZING, FOREST, ORCHARD, ETC.	15.5	16	16.5	18.5
5. SPACES OR WAYS SUBJECT TO PEDESTRIAN OR RESTRICTED TRAFFIC ONLY. (SEE NOTE 3.)	9.5	12 (SEE NOTE 2)	12.5 (SEE NOTE 1)	14.5
6. WATER AREAS NOT SUITABLE FOR SAILBOATS OR WHERE SAILBOATS ARE PROHIBITED. (SEE NOTE 12.)	14	14.5	15	17
7. A) WATER AREAS (NOT REGULATED BY CORPS OF ENGR.) SUITABLE FOR SAILBOATS, INCLUDING LAKES, PONDS, RESERVOIRS, TIDAL WATERS, RIVERS, STREAMS, AND CANALS WITH AN UNOBSTRUCTED SURFACES AREA OF: A. LESS THAN 20 ACRES B. 20 TO 200 ACRES C. 200 TO 2000 ACRES D. OVER 2000 ACRES (SEE NOTES 12, 13, & 14.)	17.5 25.5 31.5 37.5	18 26 32 38	18.5 26.5 32.5 38.5	20.5 28.5 34.5 40.5
7. B) WATER AREAS REGULATED BY CORPS OF ENGINEERS (SEE NOTE 7)	52	55	55	55
8. PUBLIC OR PRIVATE LAND AND WATER AREAS POSTED FOR RIGGING OR LAUNCHING SAILBOATS	CLEARANCE ABOVE GROUND SHALL BE 5 FEET GREATER THAN IN 7. ABOVE, FOR THE TYPE OF WATER AREAS SERVED BY THE LAUNCHING SITE.			
WHERE WIRES, CONDUCTOR, OR CABLES RUN ALONG AND WITHIN THE LIMITS OF HIGHWAY OR OTHER ROAD RIGHT-OF-WAY BUT DO NOT OVERHANG THE ROADWAY				
9. ROADS, STREET, OR ALLEYS	15.5 (SEE NOTES 6 AND 10)	15.5 (SEE NOTES 6)	16.5	18.5
10. ROADS IN RURAL DISTRICTS WHERE IT IS UNLIKELY THAT VEHICLES WILL BE CROSSING UNDER THE LINE.	15.5 (SEE NOTES 4 AND 5)	14.0 (SEE NOTES 4)	14.5 (SEE NOTES 4)	16.5

*ALWAYS REFER TO THE LATEST NESC
(REFERENCE NESC RULE 232, 2007 EDITION, FOR ADDITIONAL INFORMATION)

VERTICAL CLEARANCES OF WIRES, CONDUCTORS, AND CABLES ABOVE GROUND, ROADWAYS, RAILS, OR WATER

	REVISIONS <u>JULY, 2002</u>	TABLE 1
	DATE: <u>OCTOBER, 1992</u>	

FOOTNOTES TABLE 2:

1. Where a building, sign, chimney, antenna, tank, or other installation does not require maintenance such as painting, washing, changing of sign letters, or other operations which would require persons to work or pass between supply conductors or unguarded rigid live parts and structures, the clearance may be reduced by 2 ft.
3. A roof, balcony, or area is considered readily accessible to pedestrians if the means of access is through a doorway, ramp, window, stairway, or permanently mounted ladder. A permanently mounted ladder is not considered a means of access if its bottom rung is 8 ft. or more from the ground or other permanently installed accessible surface.
4. The required clearances shall be to the closest approach of motorized signs or moving portions of installations.
5. For the purpose of this rule, trucks are defined as any vehicle exceeding 8 ft. in height.
6. This clearance may be reduced to 3 in. for the grounded portions of the guys.
7. Windows not designed to open may have the clearance permitted for the walls and projections.
8. The horizontal clearance shall not be less than 3.5' plus the displacement of the conductor by a 6 lb/ft² wind at 60° F, final sag.
9. The horizontal clearance shall not be less than 4.5' plus the displacement of the conductor by a 6 lb/ft² wind at 60° F, final sag.
10. Where available space will not permit this value, the clearance may be reduced to 7.0 ft. for conductors limited to 8.7 KV to ground.

Note: Footnote 2 was intentionally omitted.

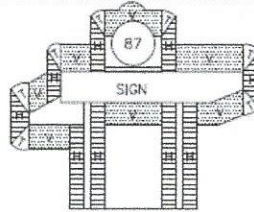

H - HORIZONTAL CLEARANCE
T - TRANSITIONAL = VERTICAL (ARC)

V - VERTICAL CLEARANCE

VOLTAGES ARE PHASE TO GROUND FOR EFFECTIVELY GROUNDED CIRCUITS

CLEARANCE FROM:	INSULATED COMMUNICATION CONDUCTORS AND CABLES; MESSENGERS; GROUNDED GUYS; NEUTRAL CONDUCTORS (IN FEET)	MULTIPLEX SUPPLY CABLE 0 - 750 VOLTS (IN FEET)	OPEN WIRE CONDUCTORS 0 - 750 VOLTS (IN FEET)	UNGUARDED RIGID LIVE PARTS, OVER 750 VOLTS TO 22 KILOVOLTS (IN FEET)	OPEN WIRE CONDUCTORS OVER 750 VOLTS TO 22 KILOVOLT (IN FEET)
1. BUILDINGS					
A. HORIZONTAL	4.5 (SEE NOTE 6)	5.0 (SEE NOTE 1)	5.5 (SEE NOTE 1 & 8)	7.0 (SEE NOTE 1)	7.5 (SEE NOTE 1,9,&10)
(1) TO WALLS, PROJECTIONS, AND GUARDED WINDOWS.					
(2) TO UNGUARDED WINDOWS. (SEE NOTE 7)	4.5	5.0	5.5 (SEE NOTE 1 & 8)	7.0	7.5 (SEE NOTE 9 & 10)
(3) TO BALCONIES AND AREA ACCESSIBLE TO PEDESTRIANS. (SEE NOTE 3)	4.5	5.0	5.5 (SEE NOTE 8)	7.0	7.5 (SEE NOTE 9 & 10)
B. VERTICAL					
(1) OVER OR UNDER ROOF OR PROJECTIONS NOT READILY ACCESSIBLE TO PEDESTRIANS. (SEE NOTE 3)	3.0	3.5	10.5	12.0	12.5
(2) OVER OR UNDER BALCONIES AND ROOFS READILY ACCESSIBLE TO PEDESTRIANS. (SEE NOTE 3)	10.5	11.0	11.5	13.0	13.5
(3) OVER ROOFS ACCESSIBLE TO VEHICLES, BUT NOT SUBJECT TO TRUCK TRAFFIC. (SEE NOTE 5)	10.5	11.0	11.5	13.0	13.5
(4) OVER ROOFS ACCESSIBLE TO TRUCK TRAFFIC. (SEE NOTE 5)	15.5	16.0	16.5	18.0	18.5
2. SIGNS, CHIMNEYS, BILLBOARDS, RADIO AND TELEVISION ANTENNAS, TANKS, AND OTHER INSTALLATIONS NOT CLASSIFIED AS BUILDINGS OR BRIDGES.					
A. HORIZONTAL; (SEE NOTE 4)					
(1) READILY ACCESSIBLE	4.5	5.0	5.5	7.0	7.5
(2) NOT READILY ACCESSIBLE	3.0	3.5	5.5 (SEE NOTES 1 & 8)	7.0	7.5 (SEE NOTE 1,9,&10)
B. VERTICAL					
(1) OVER OR UNDER CATWALKS AND OTHER SURFACES UPON WHICH PERSONNEL WALK.	10.5	11.0	11.5	13.0	13.5
(2) OVER OR UNDER OTHER PORTIONS OF SUCH INSTALLATIONS.	3.0	3.5	6.0 (SEE NOTE 1)	7.5	8.0
*ALWAYS REFER TO THE LATEST NESC (REFERENCE NESC RULE 232, 2007 EDITION, FOR ADDITIONAL INFORMATION)					

CLEARANCES OF WIRES, CABLES, AND UNGUARDED RIGID LIVE PARTS ADJACENT BUT NOT ATTACHED TO BUILDINGS AND OTHER INSTALLATIONS EXCEPT BRIDGES



REVISIONS JULY, 2001

TABLE 2

DATE: OCTOBER, 1992